

Overview 2021

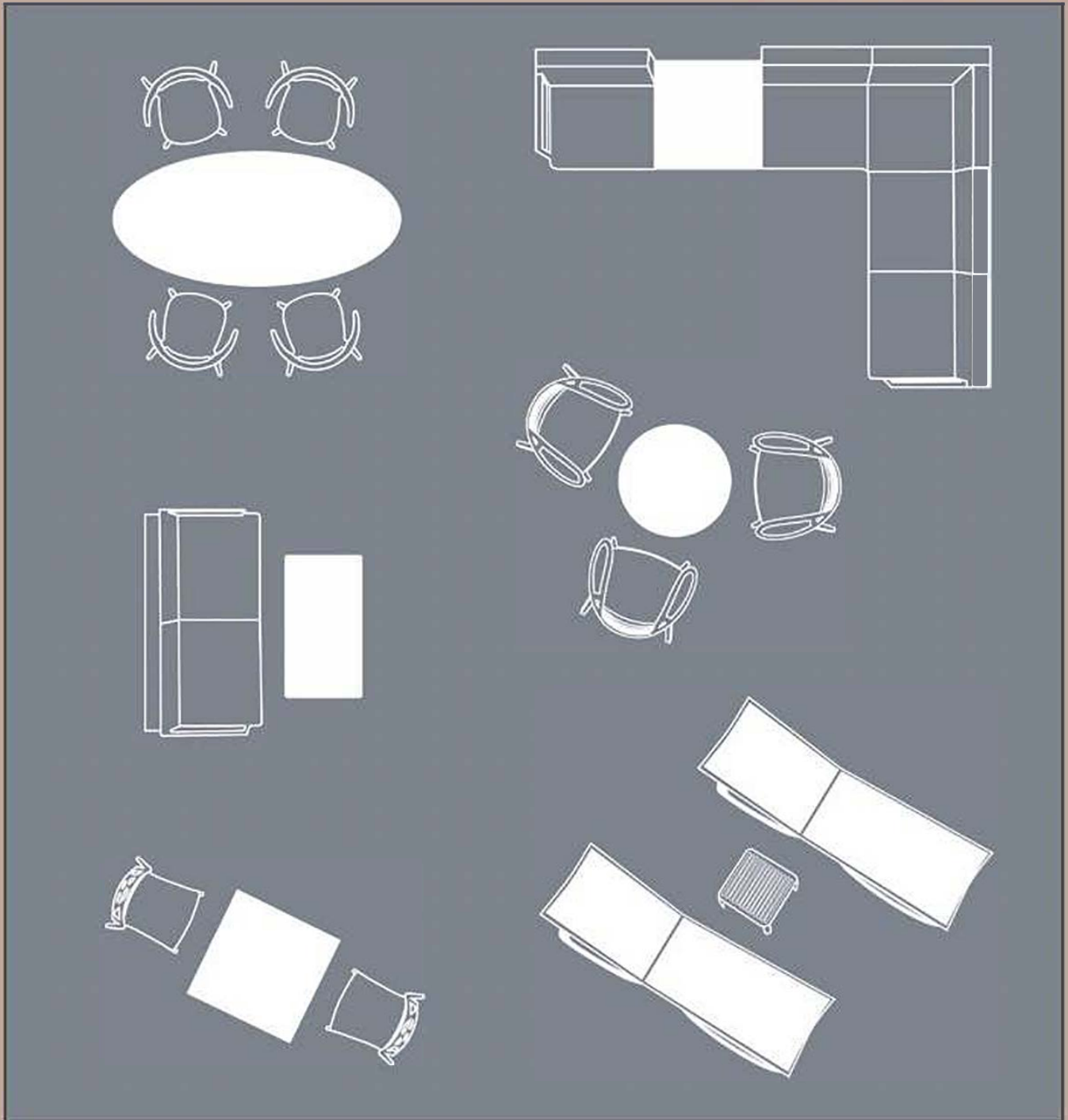

VOOLCAN

PAPATYA
DESIGN FURNITURE

Hidromekanik Makine Sanayi ve Tic. A.Ş. has been producing high qualified and innovative products since 1945. The company has started to manufacturing indoor and outdoor furniture over 30 years ago under PAPATYA brand. Keeping collections up to date by following customer expectations with its long years of experience and superior quality culture, the brand became a leader in its field.

Design aspect of the company is based on creativity, quality, functionality, resistance, research and development. Unique and rich collections include wide range of chairs, armchairs, bar stools, tables, sofas and sunloungers with suitable accessories. Qualitative raw materials such as glassfiber reinforced polypropylene, polycarbonate, metal, aluminium, stainless steel and wood, offer various combinations of indoor and outdoor furniture with trendy finishes. Color selections are done by experts to create suitable atmosphere in modern way.

PAPATYA represents todays and tomorrows furniture vision by responding to taste and requirements of global market with high qualified, aesthetic, ergonomic, affordable and maintenance free products, developed by professional and creative design team. Energy and experience meet with creative input and technological background enable the brand to build worldwide recognizing and promising projects.

JOY
PAGE 06-13



YUGO
PAGE 54-57

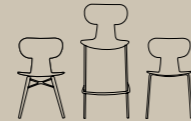

GYZA / CLASS-X
PAGE 104-113



VITAL / MARVEL
PAGE 156-163

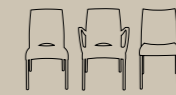

FAME
PAGE 14-19

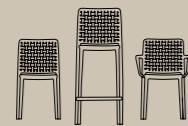

O'PERA
PAGE 58-63



EDEN
PAGE 114-119



KAREA
PAGE 164-167



X'SERA
PAGE 20-27



EGO
PAGE 64-71



MAMBO / COOL
PAGE 120-133



WAVE / ZEN
PAGE 168-177



TRIO / HERA
PAGE 28-41



OPAL
PAGE 72-83



NOSTA
PAGE 134-137



LOCA / SLIM
PAGE 178-189

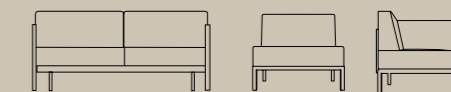

TORO
PAGE 42-45



X-TREME
PAGE 84-95



VARIA / YUMMY
PAGE 138-147



TABLES
PAGE 190-205



LUNA
PAGE 46-53



FLORA
PAGE 96-103



TIARA / ICON
PAGE 148-155



TABLE BASES
PAGE 206-225



JOY COLLECTION

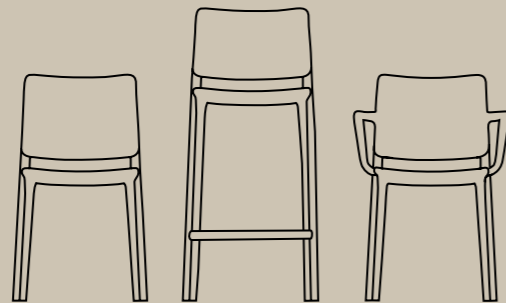

Imagine a collection that surrounds you with simplicity and uniformity in a single form. Fluid lines and light weight volume allows you to describe your own minimalistic style. Delicate details of the design, completed by glass fiber reinforced polypropylene to define a solid miracle with comfortable seating. The collection comes with chair, armchair, bar stools and their options with high qualified cushions. Special fabrics have been carefully selected by experts. You can enjoy the design at indoors and outdoors with wide color range.





JOY-K
LOTUS SQUARE TABLE BASE



JOY-K / OPUS TABLE



JOY-S BAR STOOL / OXO BAR TABLE BASE



JOY-S BAR STOOL SOFT 75 / JOY-S BAR STOOL SOFT 65 / JOY-S SOFT / JOY-K SOFT

FAME COLLECTION

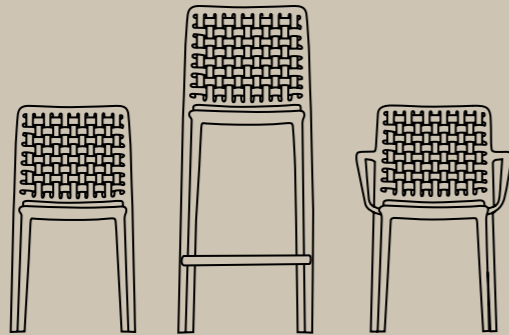

Outdoor dining areas will look its best thanks to Fame Collection. Created with a modern design and a fashionable wavy pattern, this collection adds style and comfort to outdoor spaces, complementing any existing furniture with elegance. Durable and maintenance free, the collection is made out of weather-resistant and UV protected resin. Stackable to make storage easily and comes in variety of colors.





FAME-S / FAME-K / PLUS TABLE BASE



FAME-K / PLUS TABLE BASE



FAME-S BAR STOOL

X'SERA-S



An iconic design made of gas injected polypropylene with glass fiber. Youthful and fresh start for every kind of areas with its modernized iconic chair figure. The chair comes with wide color options to create refreshing environments. Easily stored by stacking. With UV stabilizer, it has resistant to seasonal conditions.



X'SERA-S / PLUS TABLE BASE





X'SERA-S



TRIO-S



Timeless collection is the description of traditional and contemporary design aspect. Vertical lines, wooden texture and natural tones come together to create modernization of delicate details. Stackable, durable and maintenance free. With UV stabilizer, it has resistant to seasonal conditions.





TRIO-S SOFT / LOTUS SQUARE TABLE BASE



TRIO-S / LOTUS SQUARE TABLE BASE



TRIO-S SOFT / WOX TABLE WITH BEECH LEGS / LOTUS SQUARE TABLE BASE

HERA COLLECTION

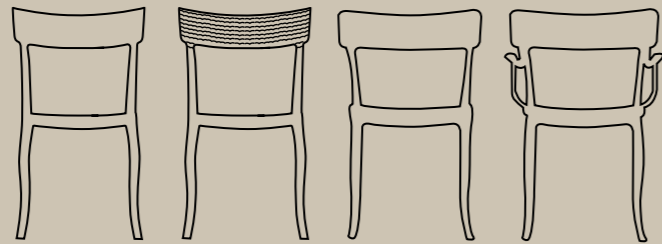

Hera Collection features a wide range of models in a single form. It offers numerous shapes with a combination of polycarbonate and polypropylene. With its design that combines dynamism and elegance, the collection, which has become the leading player of the areas, provides long-lasting use with durability-based raw materials. In addition to chair and armchair alternatives created by the combination of two different materials, fully polypropylene resin based matt textured chair model can be preferred. As an unconventional design, Hera Rattan chair with wavy pattern creates a new perspective for conventional outdoor spaces.







HERA-SP / ONIX TABLE



HERA-SP RATTAN



TORO COLLECTION

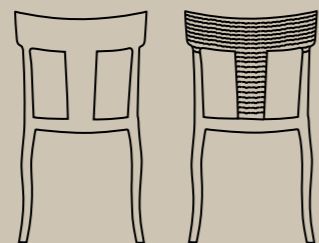

The dynamic attitude of the Toro Collection and natural color alternatives add a unique texture to the spaces. The chair, which can be used for indoor and outdoor areas with superior quality cushion combinations, takes the design to the next level with the strength that received from durable raw materials. Stackable, durable and maintenance free. With UV stabilizer, it has resistant to seasonal conditions.



TORO-S RATTAN



TORO-SRATTAN



TORO-SRATTAN / MAXIMA TABLE

LUNA COLLECTION

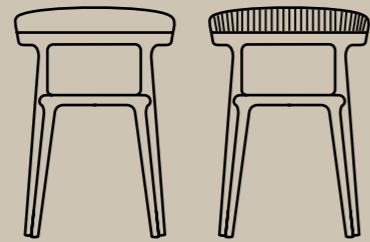

With its naive and balanced form, the Luna collection will be the new definition of beauty in decoration. Expertly processed and combined polycarbonate and polypropylene resins, Luna armchair will finalize your quest for functionality.

The collection comes with stylish color alternatives. Designed with vertical lines and made entirely of glass fiber reinforced polypropylene, Luna Stripe armchair is waiting to be discovered with its matte texture. Stackable, durable and maintenance free. With UV stabilizer, it has resistant to seasonal conditions.





LUNA STRIPE



LUNA STRIPE



LUNA WITH CAP CUSHION



LUNA / ONIX TABLE



YUGO COLLECTION

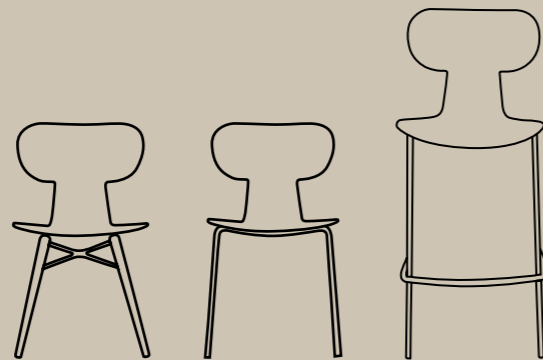

Being a design enthusiast is just one of your reasons for choosing the Yugo Collection. With its ergonomic back support and irresistible comfort, its energetic effect in the professional areas will surround you. With chair and bar chair alternatives, this collection is stackable and an extremely durable choice. With chair and bar chair alternatives, this collection is stackable and an extremely durable choice. Flexible and lightweight seating font can be combined with metal and wood foot options. Schools, conference rooms, libraries, in short, are designed for self-indulgent people in places that bring us together.



YUGO-S WOX



YUGO-S BAR STOOL / YUGO-S / SPARK TABLE BASE

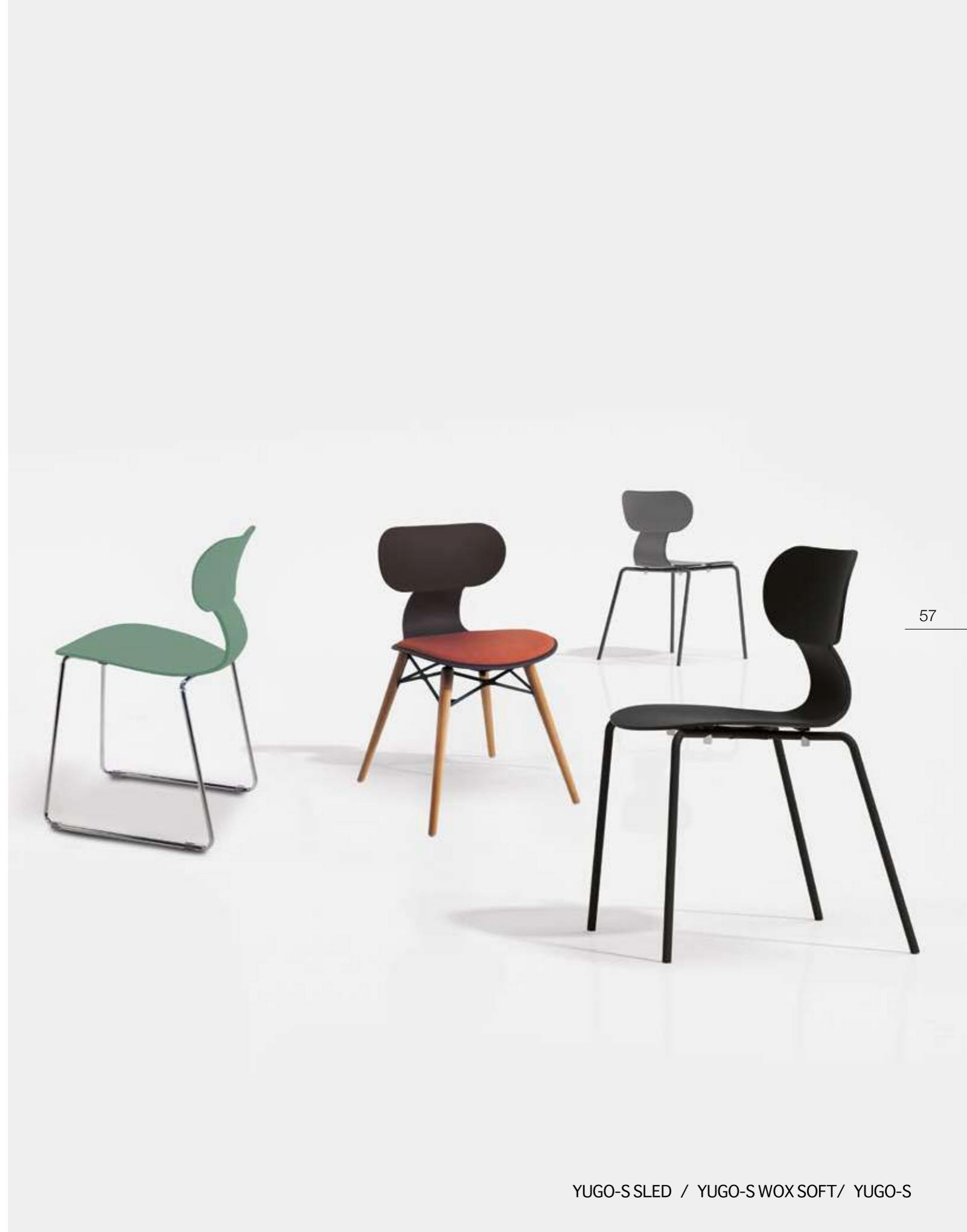

YUGO-S SLED / YUGO-S WOXSOF / YUGO-S

O'PERA COLLECTION

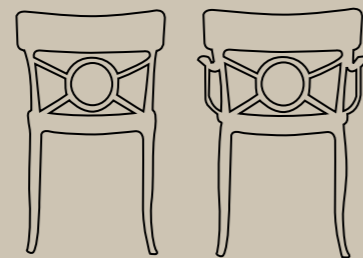

Opera Collection, which emerged as a result of the expertly processed polypropylene and polycarbonate raw materials, is a remarkable nobleman among all our chair groups with its innovative design. The collection, which makes a difference by blending traditional texture with contemporary touches, creates a cult theme in decoration with a wide range of color options. The collection is more ambitious than ever with its unique designed fixed cushion options for indoor and outdoor use.



O'PERA-K SOFT / O'PERA-S / O'PERA-K





O'PERA-S / O'PERA-K
LOTUS ROUND TABLE BASE

EGO COLLECTION



A colorful and cheerful collection with polypropylene base and polycarbonate back will add a joyful spirit to your life. The family of chair, armchair and bar stools can capture the desired comfort along with functionality. Suitable for indoor and outdoor use. The bar stools belonging to the collection are powered by aluminum material combination with polypropylene and polycarbonate raw materials.



EGO-K / EGO-S / EGO-ROCK



EGO-K / LOTUS ROUND SIDE TABLE BASE



EGO-K / EGO-S



EGO-ROCK / PUNTO TABLE BASE



EGO-ROCK BAR STOOL



EGO-K BAR STOOL

OPAL COLLECTION



Opal Collection, which has an eye-catching splendor with the bright and stylish texture of polycarbonate raw material, offers transparent and solid color alternatives. Having many versions, the collection has complementary models such as armchair with metal and wooden legs, office chair with wheels, waiting chair with central base.

With its velvety texture and spacious volume, the **Opal Pro Collection** will be your solution partner for professional common areas. The collection, which adapts easily to many styles with seven different natural color options, meets its users with a choice of chrome plated and powder coated metal, beech, iroko and oak wooden legs. The design for the Pro version is made of glass fiber reinforced polypropylene raw material. It is available in all versions of the Opal Collection. You can reflect your style by choosing the font and leg color in the same shades. Suitable for indoor and outdoor use with special fabric cushion alternatives.



OPAL-ML PRO



OPAL-ML PRO / X-TREME S PRO / LOTUS ROUND TABLE BASE



OPAL WOX PRO SOFT WITH BEECH LEGS / WOX TABLE WITH BEECH LEGS

OPAL-ML PRO SOFT / OPAL WOX PRO SOFT WITH IROKO LEGS / WOX SIDE TABLE WITH IROKO LEGS



OPAL-ML PRO

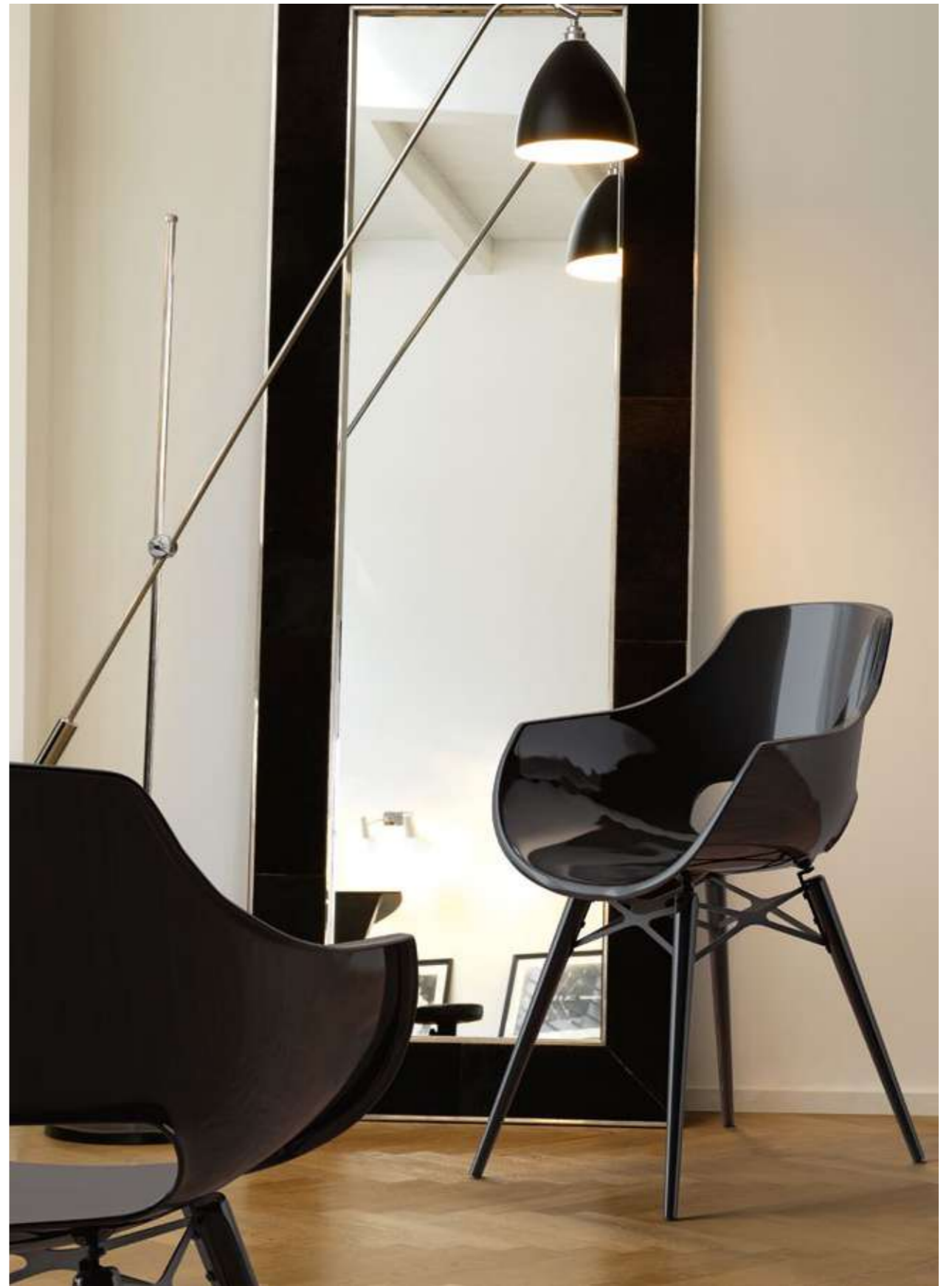

OPAL WOX WITH BLACK LAQUARED BEECH LEGS



OPAL WOX WITH IROKO LEGS



OPAL WOX WITH IROKO LEGS / WOX TABLE WITH IROKO LEGS



OPAL WOX WITH BEECH LEGS / OPAL CHIEF / OPAL-MD

OPAL WOX WITH IROKO LEGS / OPAL-ML / OPAL-ML PRO

X-TREME COLLECTION

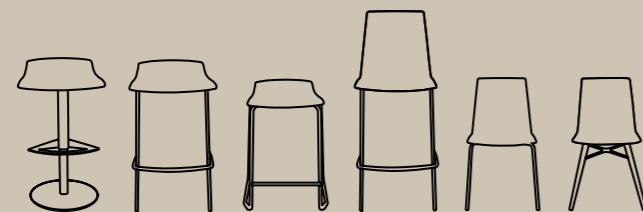

X-treme Collection acts like a joker in venues with its contemporary design and ergonomic back support. Polycarbonate seat exists in shiny transparent and solid colors. The collection is available with a selection of chairs with metal and wooden leg, bar stools with different heights. Available in fully upholstered shell version by the touch of luxurious fabrics. In soft versions, the collection is even more comfortable. Wide range of the X-treme collection enhances the product in terms of aesthetics and comfort. Suitable for residential and professional use.

Natural, warm and contemporary design. The **X-treme Pro Collection** is for professional spaces with its matte velvety texture. For Pro edition, the design was created by glassfiber reinforced polypropylene raw material. Available in all shapes of X-treme Collection. You can reflect your style by choosing the font and leg color in the same shades. With beech, iroko and oak leg options, you can capture the serenity of the Scandinavian style.



X-TREME S PRO



X-TREME S WOX PRO WITHIROKO LEGS / WOX TABLE WITHIROKO LEGS



X-TREME BSL PRO SOFT / X-TREME SD WOX WITHIROKO LEGS / X-TREME S PRO SOFT

X-TREME S WOX PRO SOFT WITHBEECH LEGS / X-TREME S WOX PRO SOFT WITHIROKO LEGS



X-TREME S WOX WITH BEECH LEGS



X-TREME S / MODUS TABLE BASE



X-TREME BSS / X-TREME BSL



X-TREME B



X-TREME S PRO / X-TREME B / X-TREME SWOX WITH BECH LEGS / X-TREME SWOX WITH IROKO LEGS

X-TREME S / X-TREME BSL / X-TREME BSS / X-TREME SLED

FLORA

COLLECTION

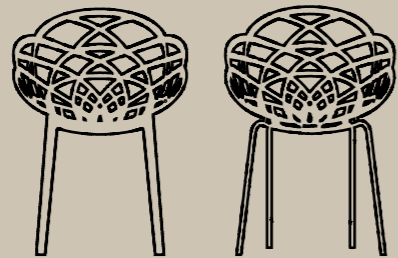

Sophisticated, floral, colorful. If there's a Flora Armchair in a place, all eyes are on it. Featuring a floral shape with its unique curves, the polycarbonate front seat is offered with metal and polypropylene legs. The product, which is a favorite of the place, retains its bright color for many years thanks to UV stabilizer.





FLORA-PP



FLORA-PP





FLORA-ML / FLORA-PP / FLORA CHIEF

GYZA

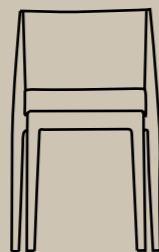

With its colorful and cheerful attitude, the Gyza chair is a real energetic. Shaped by the brightness and strength of polycarbonate raw material, the design is offered with transparent and solid color alternatives. With its minimal and aesthetic stance, the Gyza chair will be the favorite of the place where it is located.





GYZA



GYZA / PUNTO TABLE BASE



GYZA / PUNTO TABLE BASE

CLASS-X

COLLECTION

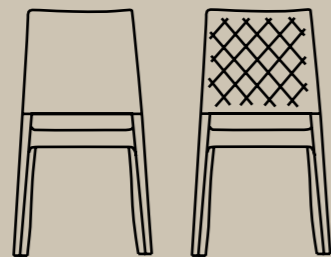

Class-X is the new definition of elegance you are looking for, regardless of whether you are at an event table or at your dining table. Polycarbonate monoblock product evokes classic style with curved leg detail.

It is presented with two different back details with self-patterned and completely transparent. Its majestic volume with bright finish accompanies your dream world. Cushion alternatives produced with high quality fabrics provide superior comfort.





CLASS-X



CLASS-XC SOFT / PUNTO TABLE BASE

EDEN COLLECTION

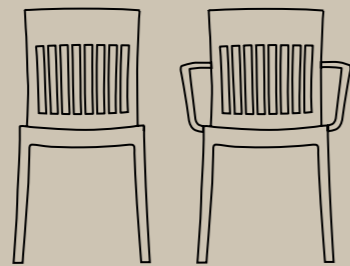

Purity, grace and charm; it's all in this collection. Eden Collection, which comes with chair and armchair options, allows us to capture the wooden feeling with its natural texture. A choice that makes a difference at indoors and outdoors. It provides ease of use with multiple color alternatives and stackability. It accompanies your long-term breaks with fixed cushion and puff cushion options. With UV stabilizer, it has resistant to seasonal conditions. Maintenance free.



EDEN-S SOFT



EDEN-K SOFT / EDEN-S SOFT



EDEN-S / EDEN-K / LOTUS SQUARE TABLE BASE

MAMBO

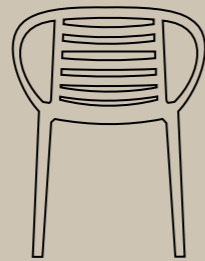

Mambo Armchair will go beyond all your experiences so far with its smart volume and ergonomic structure for your superior comfort needs. Offering a combination of dynamism and elegance, the design is suitable for indoor and outdoor use. It accompanies your long-term breaks with fixed cushion and puff cushion options. Easily stored by stacking. With UV stabilizer, it has resistant to seasonal conditions. Mambo armchair prepared with natural tones. This armchair will be the choice of those who like to be intertwined with nature.



MAMBO / MAMBO SOFT



MAMBO / MAXIMA TABLE



MAMBO / GAMA TABLE BASE



MAMBO SOFT / MAXIMA TABLE



COOL

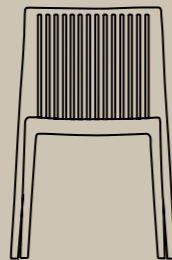

A sense of nobility is a feeling that a Cool Chair will evoke in you. Adapted from a metal texture, this charismatic style solves your need for comfort with dynamism and modernism.

From multiple color alternatives, you can easily combine the ones that suits you. Made of high quality polypropylene, the product is stackable, resistant to seasonal conditions and maintenance free.

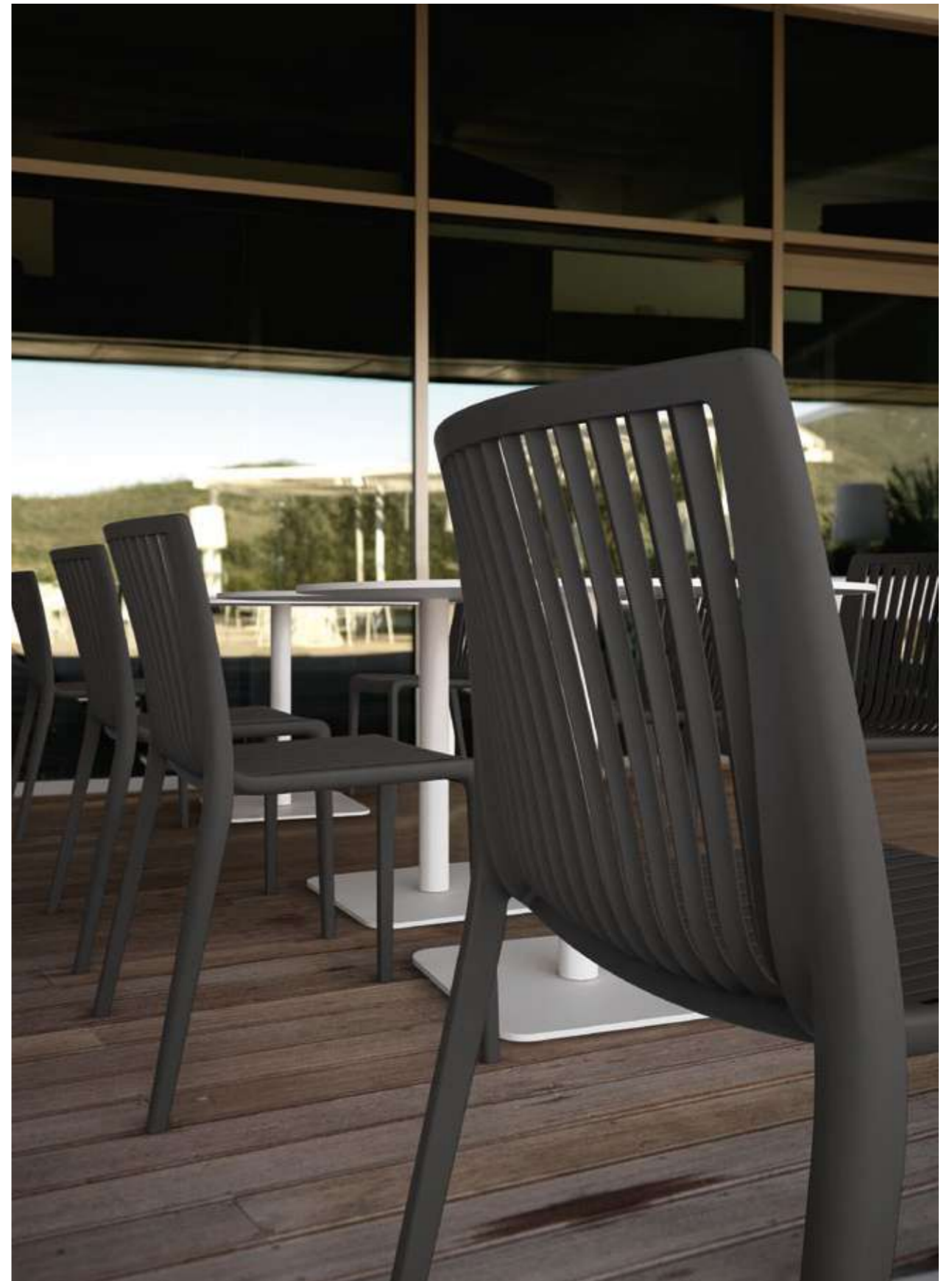





COOL



COOL

NOSTA-S



This design is a complete Aegean. Imagine sirtaki in a Greek Tavern, a Mediterranean dream on the beach, the sea, blue atmosphere.
The full polypropylene monoblock chair is designed to refresh spaces with soft shades. With superior quality and high-end durability, it will be your companion for many years.
Stackable, durable and maintenance free. With UV stabilizer, it has resistant to seasonal conditions.

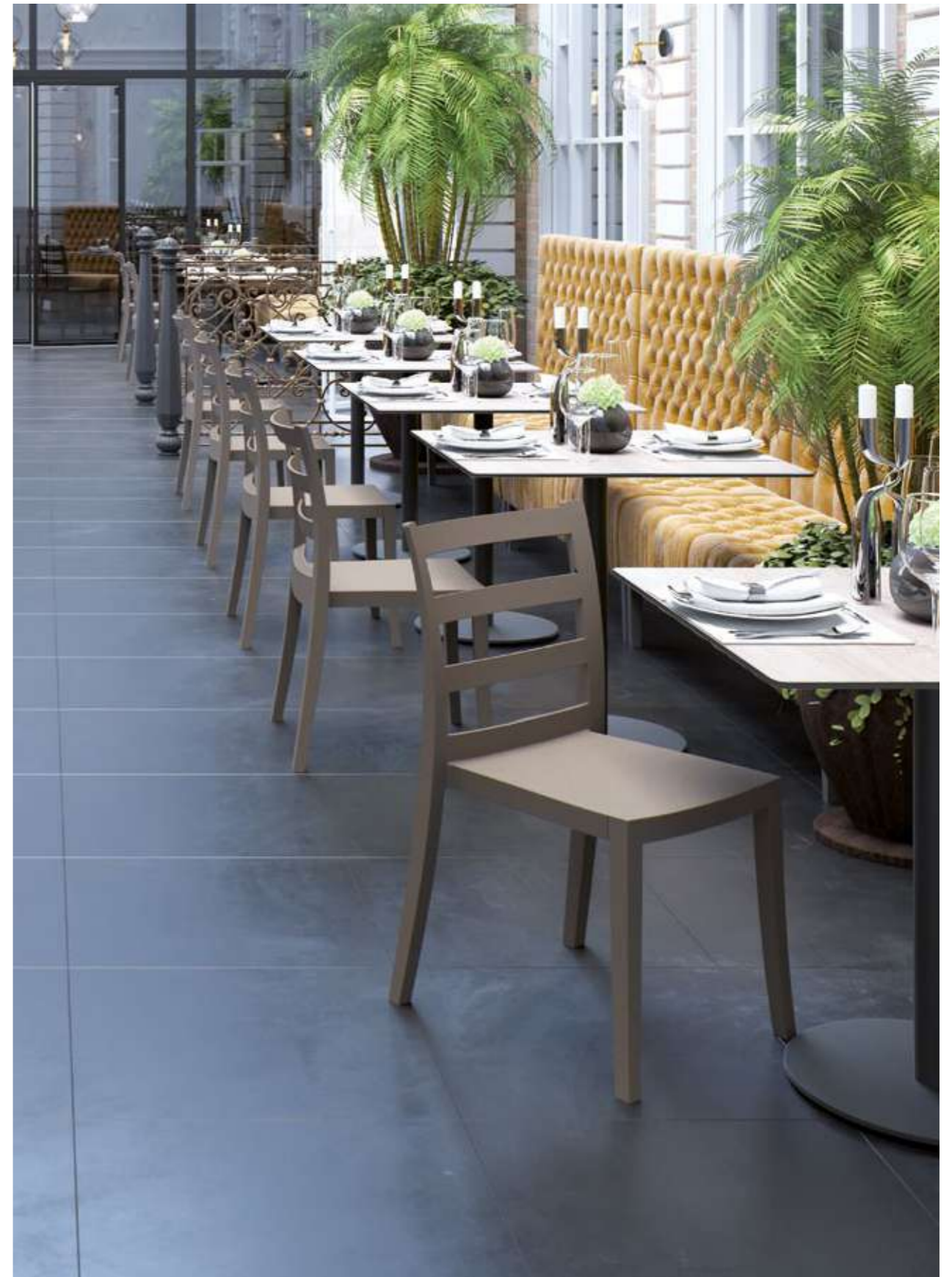

NOSTA - S / LOTUS ROUND TABLE BASE



NOSTA-S SOFT / LOTUS SQAURE TABLE BASE

VARIA-S

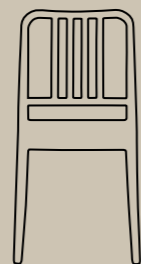

An iconic chair design with striped back detail. Functional, versatile and comfortable. Varia is suitable for both residential and professional use. The chair can be combined with puffy cushion to catch ultra comfort seating desire. It provides ease of use with multiple color alternatives and stackability. With UV stabilizer, it has resistant to seasonal conditions.







YUMMY

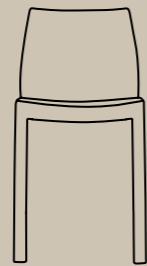

Your search for seating ends with a simple and smart design. Polypropylene monoblock chair has self-patterned wooden texture. Yummy is extraordinarily comfortable and durable. The chair, which will be with you for a long years, is offered in multiple color alternatives. Stackable and easy to maintain. It retains the first-day quality thanks to UV stabilizer.





TIARA



The curves of Tiara Armchair, which remind you of the Queen's crown, take your design sense to the next level. Polypropylene seat is offered with chrome and electrostatic powder coated metal leg alternatives. Stackable and easy to maintain. It retains the first-day quality thanks to UV stabilizer.

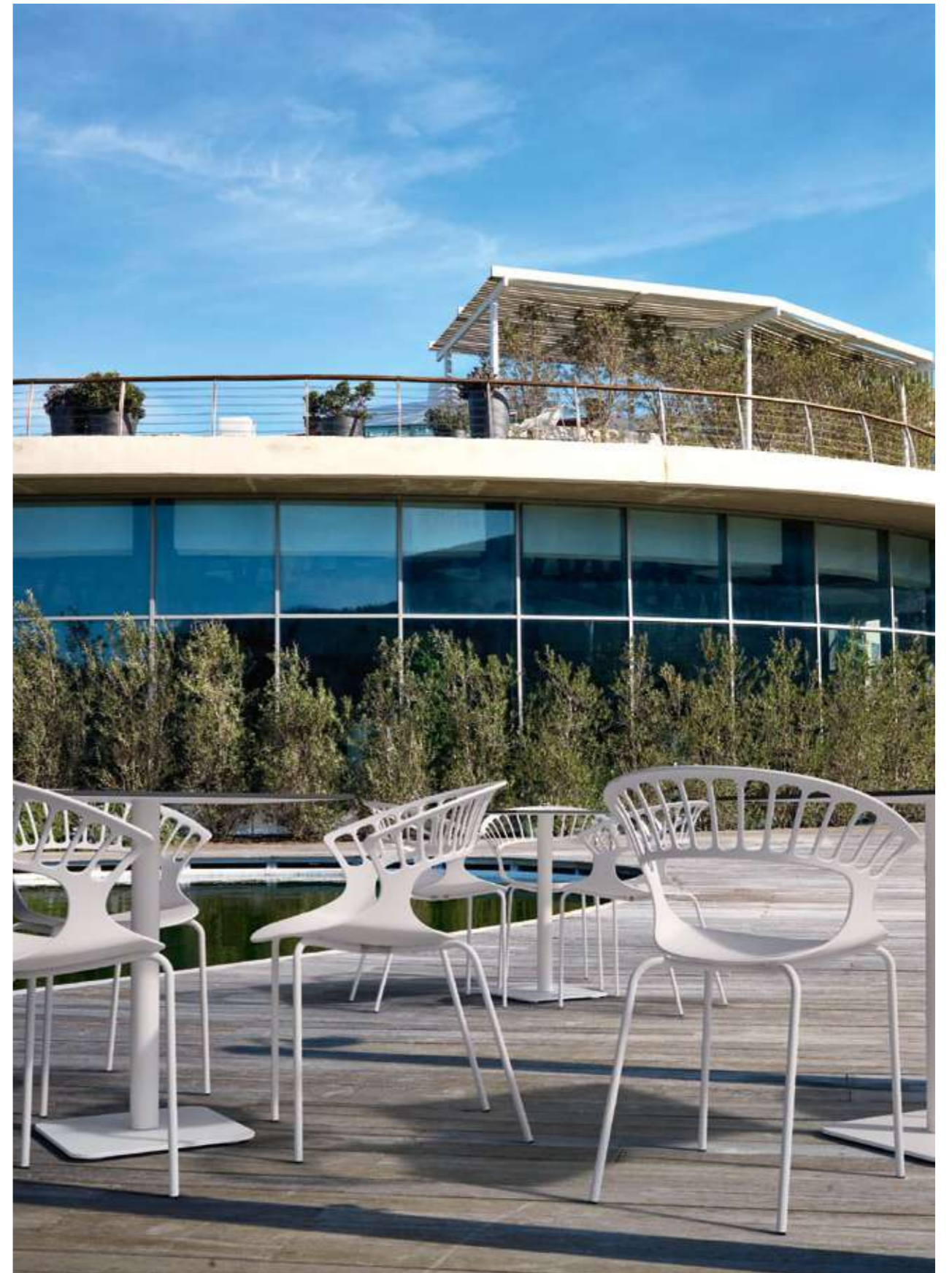

TIARA / LOTUS SQUARE TABLE BASE



ICON COLLECTION

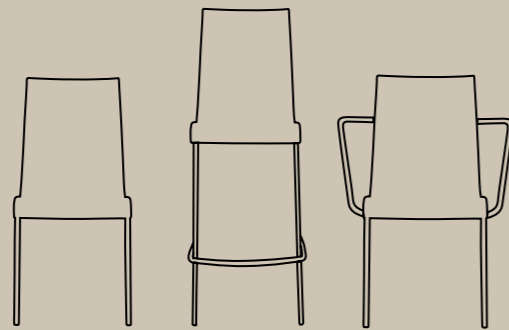

With the strength of high quality polypropylene raw material, Icon Collection adapts to professional areas. Flexible and ergonomic back support makes you feel the difference. The collection is offered as a chair, armchair and bar stool of two different heights. In addition to the chrome leg option, cataphorized electrostatic powder coated legs are suitable for outdoor use. Stackable and easy to maintain. It retains its first-day quality thanks to its uv stabilizer.

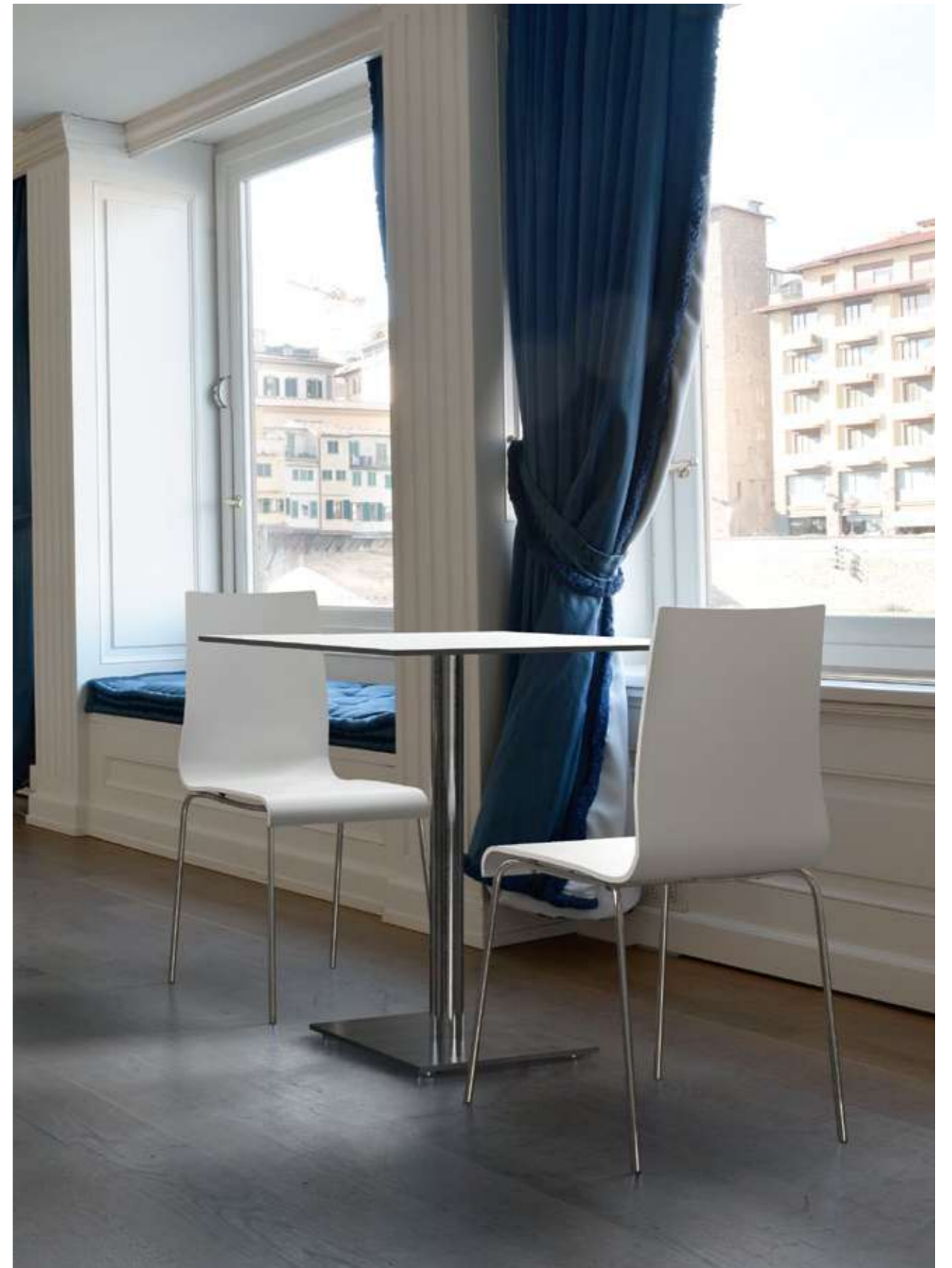

ICON-S / MODUS TABLE BASE



ICON-SD



ICON-BDK / ICON-B

VITAL COLLECTION

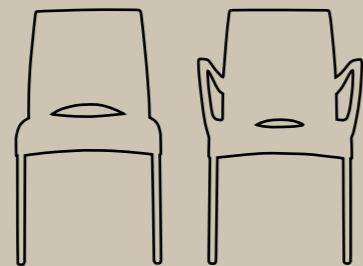

Design of the Vital Collection, a perfect combination of polypropylene and aluminium material, provides ease of use indoors and outdoors. Offering superior comfort, the product can be stacked to store easily. Vital chair and armchair retain their pure color for many years thanks to uv stabilizer.



VITAL-K / VITAL-S



MARVEL-S

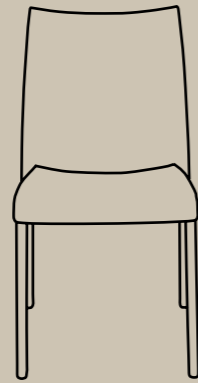

Marvel Chair is created for indoor and outdoor dining areas. Glassfiber reinforced polypropylene seat is combined with aluminium legs. Stackable and maintenance free. Suitable for residential and professional use.



MARVEL-S



KAREA

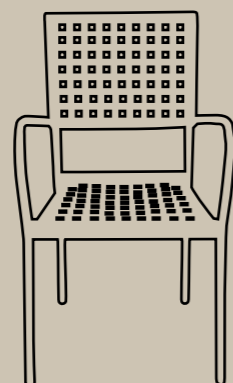

Embrace nature with a Karea Chair. Enjoy comfort with self-patterned wooden wavy texture. The harmony of aluminium frame with high quality polypropylene raw material offers superior comfort. Karea armchair with special color options is stackable and maintenance free.





KAREA
OXO TABLE BASE

WAVE COLLECTION

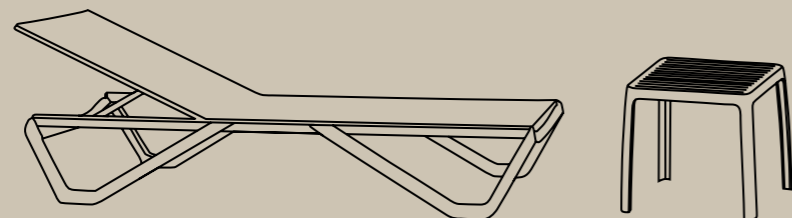

The perfect product of our design journey that we've experienced over the years. Wave sunlounger is beyond all your experience so far. High strength mesh fabric, aluminium frame structure, premium quality glass fiber reinforced polypropylene leg details. Carrying capacity of 1000 kilograms. Simply, it's much more than what is desired for a sunlounger. All the details have been designed for you. Back support adapts to your body shape to offer superior comfort. Thanks to its hidden wheels, it can be easily scrolled. A new generation of sunlounger can be stored by stacking. Wave sunlounger retains its original color for many years thanks to UV stabilizer. You can combine the sunlounger with Wave Side Table. Glass fiber reinforced polypropylene side table is suitable to create a visual compatibility.



WAVE SUNLOUNGER / WAVE SIDE TABLE



WAVE SUNLOUNGER / WAVE SIDE TABLE



WAVE SUNLOUNGER / WAVE SIDE TABLE

ZEN COLLECTION

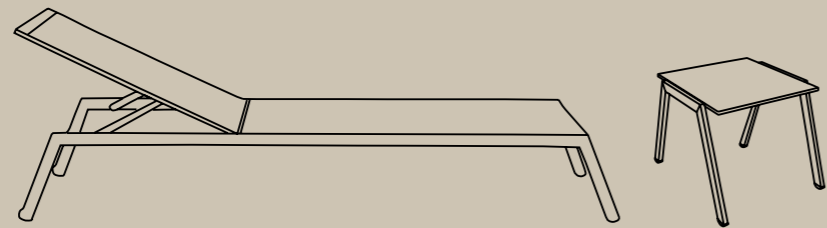

The luxury of stainless steel is combined with the comfort of professional mesh fabric. Zen Sunlounger is the new definition of luxury. Stainless steel structure, which affects you with its unbearable charm, gives you confidence with its professional stance. Breathable technical mesh fabric gives long-term colour stability. Stackable sunlounger provides ease of use. Hidden wheels that make sliding easier take this design wonder product to the next level. Gradual multipositioning backrest offers superior comfort. You can combine the sunlounger with Zen Side Table. Side table with compact top and stainless steel legs is suitable to create a visual compatibility.





LOCA COLLECTION

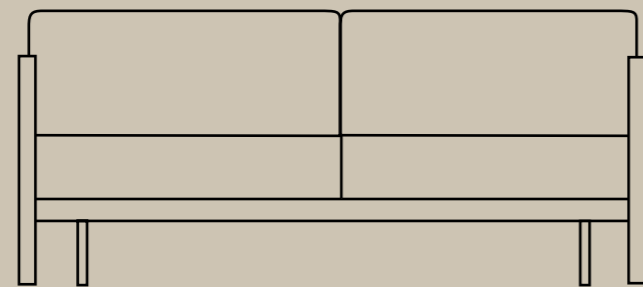

The Loca Sofa Collection allows you to dream of a lush garden, a large terrace, a peaceful poolside. With the strength of metal, the durability of mesh fabric, the comfort of superior quality cushions, outdoor spaces become a pleasure area. Large, spacious, rounded folds adapt to every living space. You can create your own sofa set with single or multiple seating options. Technical mesh fabric offers professional use. Breathable cushions have quick dry specification.

Thanks to professional mesh fabric, it retains its original color for many years. Stain resistant and easy to maintain. You can complete your sofa set with a side table and a middle table with compact top.



LOCA SOFA LS 02



LOCA SOFA LS 3+3 / LS01 / PUF 740x740 / SIDE TABLE



LOCA SOFALS 3+1



LOCA SOFALS 03



SLIM COLLECTION

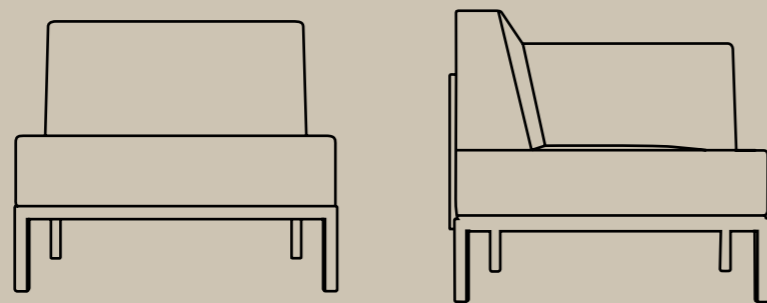

Sharp lines, natural shades and exceptional product development. The Slim Sofa Collection will add spirit to common living spaces with its cool and minimalistic design. It is possible to create single, multiple or L-shaped sofas with adaptive combinations of single and corner modules. It is strong and stable with aluminium and stainless steel based structure. Technical mesh fabric offers professional use. Breathable cushions have quick dry specification. Thanks to professional mesh fabric, it retains its original color for many years. Stain resistant and easy to maintain. You can complete your sofa set with a side table and a middle table with compact top. Then, all you have to do is enjoying the Slim Sofa.



SLIM SOFA / SIDE TABLE



SLIM SOFA SET / SIDE TABLE / CENTER LOW TABLE

MODULAR UNITS



MAIN MODULE (A)



CORNER MODULE (B)



ARMREST (C)



CENTER LOW TABLE (D)



SIDE TABLE (E)

LIMITLESS COMBINATIONS



TABLES

Modern and stylish table collections are designed to create functional living spaces compatible with chair collections. You can find the ideal solution for professional and residential environments. Table collections can be adapted to indoor and outdoor spaces with different table top options made of compact laminate and polymer laminate materials. Table base varieties from metal to wood content are rich and elegant. Electrostatic powder coated metal table bases are suitable for indoor and outdoor professional use. By the cataphorise application, decorative designs are upgraded to an outdoor decoration item. Table collections are robust and maintenance free. Single tone choices from table and chair collections catch perfect harmony.

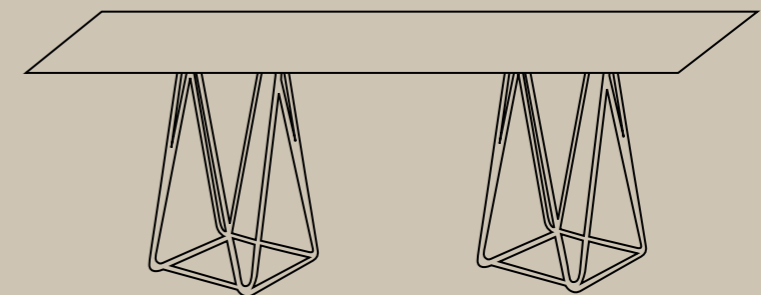
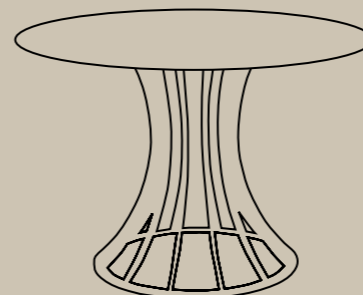
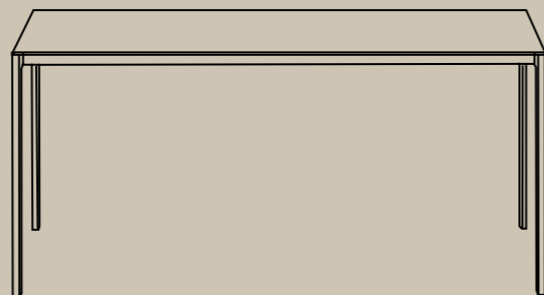
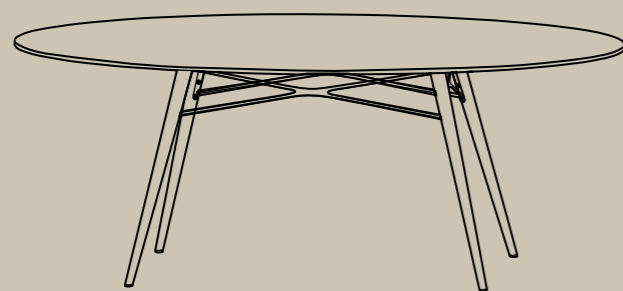





MAXIMA COLLECTION









ONIX COLLECTION



TRIO COLLECTION

TABLE BASES

Wide range of functional table bases are adaptive to a given architecture. Different shapes and sizes can be chosen to create versatile combinations. Table bases range guarantees maximum stability. Ideal for indoor and outdoor uses with respect to the useful material choices. Table base varieties from metal to wood content are rich and elegant. Electrostatic powder coated metal table bases are suitable for indoor and outdoor professional use. By the cataphorise application, decorative designs are upgraded to an outdoor decoration item.

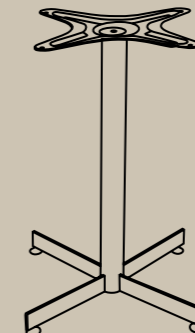
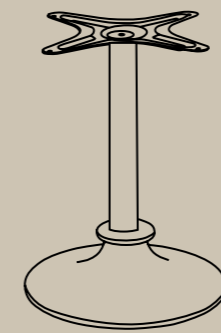
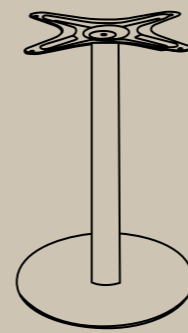
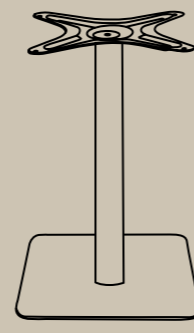
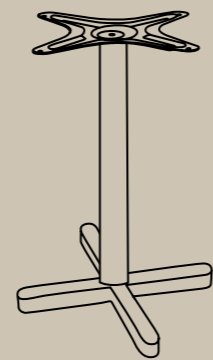
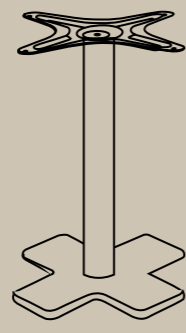
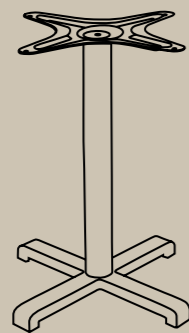



















CUSHIONS &
UPHOLSTERED

REMOVABLE CUSHIONS

X'SERA-S

with dressed cushion

COVER TYPES:
Silvertex / Stamskin Zen
Valencia



TRIO-S

with dressed cushion

COVER TYPES:
Silvertex / Stamskin Zen
Valencia



HERA-S

with dressed cushion

COVER TYPES:
Silvertex / Stamskin Zen
Valencia



HERA-K

with dressed cushion

COVER TYPES:
Silvertex / Stamskin Zen
Valencia



HERA-SP

with dressed cushion

COVER TYPES:
Silvertex / Stamskin Zen
Valencia



HERA-SP Rattan

with dressed cushion

COVER TYPES:
Silvertex / Stamskin Zen
Valencia



TORO-S

with dressed cushion

COVER TYPES:
Silvertex / Stamskin Zen
Valencia



TORO-S Rattan

with dressed cushion

COVER TYPES:
Silvertex / Stamskin Zen
Valencia



OPERA-S

with dressed cushion

COVER TYPES:
Silvertex / Stamskin Zen
Valencia



OPERA-K

with dressed cushion

COVER TYPES:
Silvertex / Stamskin Zen
Valencia



LUNA

with cap cushion

COVER TYPES:
Silvertex / Stamskin Zen
Batyline Eden / Valencia



LUNA STRIPE

with cap cushion

COVER TYPES:
Silvertex / Stamskin Zen
Batyline Eden / Valencia



EGO-S

with dressed cushion

COVER TYPES:
Silvertex / Stamskin Zen
Valencia



EGO-K

with dressed cushion

COVER TYPES:
Silvertex / Stamskin Zen
Valencia



EGO-ROCK

with dressed cushion

COVER TYPES:
Silvertex / Stamskin Zen
Valencia



OPAL

with puffy cushion (LONG)

COVER TYPES:
Era



OPAL

with puffy cushion (SHORT)

COVER TYPES:
Era



OPAL

with sticked cushion

COVER TYPES:
Silvertex / Batyline Eden / Stamskin Zen
Valencia / Maglia / Main Line Flax / Era



GYZA

with dressed cushion

COVER TYPES:
Silvertex / Stamskin Zen
Valencia



GYZA

with sticked cushion

COVER TYPES:
Silvertex / Batyline Eden / Stamskin Zen
Valencia / Maglia / Main Line Flax / Era



CLASS-X / CLASS-XC

with dressed cushion

COVER TYPES:
Silvertex / Stamskin Zen
Valencia



CLASS-X / CLASS-XC

with sticked cushion

COVER TYPES:
Silvertex / Batyline Eden / Stamskin Zen
Valencia / Maglia / Main Line Flax / Era



EDEN-S

with foam cushion

COVER TYPES:
Sunbrella / Etisilk



EDEN-K

with foam cushion

COVER TYPES:
Sunbrella / Etisilk



MAMBO

with puffy cushion (LONG)

COVER TYPES:
Era



MAMBO

with puffy cushion (SHORT)

COVER TYPES:
Era



COOL

with dressed cushion

COVER TYPES:
Silvertex / Stamskin Zen
Valencia



VARIA-S

with foam cushion

COVER TYPES:
Sunbrella / Etisilk



FIXED CUSHIONS

JOY-S Soft

COVER TYPES:
Silvertex / Stamskin Zen
Valencia / Maglia
Main Line Flax / Era



JOY-S Soft

COVER TYPES:
Silvertex / Stamskin Zen
Valencia / Maglia
Batyline Eden / Main Line Flax / Era



JOY-K Soft

COVER TYPES:
Silvertex / Stamskin Zen
Valencia / Maglia
Main Line Flax / Era



JOY-K Soft

COVER TYPES:
Silvertex / Stamskin Zen
Valencia / Maglia
Batyline Eden / Main Line Flax / Era



X'SERA-S Soft

COVER TYPES:
Silvertex / Stamskin Zen
Valencia / Maglia
Batyline Eden / Main Line Flax / Era



TRIO-S Soft

COVER TYPES:
Silvertex / Stamskin Zen
Valencia / Maglia
Batyline Eden / Main Line Flax / Era



HERA-S Soft

COVER TYPES:
Silvertex / Stamskin Zen
Valencia / Maglia
Batyline Eden / Main Line Flax / Era



HERA-K Soft

COVER TYPES:
Silvertex / Stamskin Zen
Valencia / Maglia
Batyline Eden / Main Line Flax / Era



HERA-SP Soft

COVER TYPES:
Silvertex / Stamskin Zen
Valencia / Maglia
Batyline Eden / Main Line Flax / Era



HERA-SP Rattan Soft

COVER TYPES:
Silvertex / Stamskin Zen
Valencia / Maglia
Batyline Eden / Main Line Flax / Era



MAMBO Soft

COVER TYPES:
Silvertex / Stamskin Zen
Valencia / Maglia
Batyline Eden / Main Line Flax / Era



TORO-S Soft

COVER TYPES:
Silvertex / Stamskin Zen
Valencia / Maglia
Batyline Eden / Main Line Flax / Era



TORO-S Rattan Soft

COVER TYPES:
Silvertex / Stamskin Zen
Valencia / Maglia
Batyline Eden / Main Line Flax / Era



OPERA-S Soft

COVER TYPES:
Silvertex / Stamskin Zen
Valencia / Maglia
Batyline Eden / Main Line Flax / Era



OPERA-K Soft

COVER TYPES:
Silvertex / Stamskin Zen
Valencia / Maglia
Batyline Eden / Main Line Flax / Era



EDEN-S Soft

COVER TYPES:
Silvertex / Stamskin Zen
Valencia / Maglia
Batyline Eden / Main Line Flax / Era



EDEN-K Soft

COVER TYPES:
Silvertex / Stamskin Zen
Valencia / Maglia
Batyline Eden / Main Line Flax / Era



X-TREME S Soft

COVER TYPES:
Era / Main Line Flax / Valencia
SteelCut3



X-TREME S WOX Soft

COVER TYPES:
Era / Main Line Flax / Valencia
SteelCut3



UPHOLSTERED

OPAL-KD



OPAL-KD WOX



OPAL-MD



COVER TYPE:
Valencia

X-TREME-SD



X-TREME-BSLD



X-TREME-BSSD



COVER TYPE:
Valencia / Era

X-TREME-SLED D







X-TREME-BD



COVER TYPE:
Valencia / Era

X-TREME-SD WOX with beech wood legs



-  Natural beech wood
-  Wenge lacquered beech wood
-  Black lacquered beech wood
-  White lacquered beech wood

COVER TYPE:
Valencia / Era

ICON-SD



ICON-BD



ICON-BDK



COVER TYPE:
Valencia / Artificial Leather

COVER TYPES AND COLOURS

GROUP C ERA BY CAMIRA



INDOOR
USAGE



CIGARETTE
& MATCH

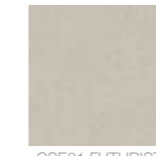

CSE01 FUTURIST



CSE02 GENERATION



CSE03 LIFETIME

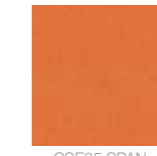

CSE05 SPAN

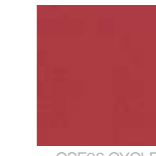

CSE06 CYCLE

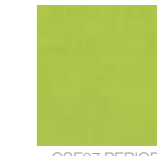

CSE07 PERIOD



CSE08 CHAPTER

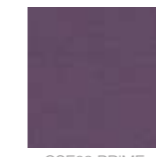

CSE09 PRIME



CSE10 EVERLASTING



CSE11 FORECAST



CSE12 PERENNIAL



CSE13 PRESENT

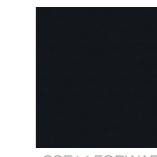

CSE14 FORWARD



CSE15 STAGE



CSE16 TIMELAPSE

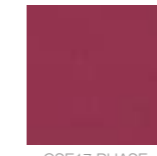

CSE17 PHASE



CSE18 EVENT

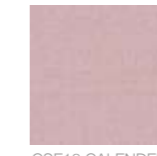

CSE18 CALENDER

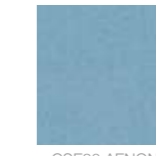

CSE20 AENON

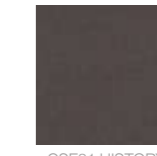

CSE21 HISTORY



CSE23 OCCURENCE



CSE24 DATE



CSE25 SEQUENCE

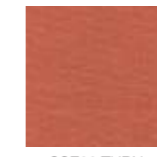

CSE26 TURN



CSE27 MEASURE



CSE28 EXTEND

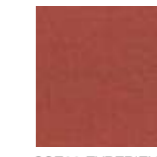

CSE29 EXPERIENCE



CSE30 TRANSITION



CSE31 SPLITSECOND



CSE32 OCCASSION



CSE33 ANALOGUE



CSE34 ENDURANCE



CSE35 SIGNATURE



CSE36 NOTATION



CSE37 REST



CSE38 ALLOWANCE



CSE39 YOUTH



CSE40 MATURITY



CSE41 QUOTA



CSE42 RANGE



CSE43 LATE



CSE44 ELAPSE



CSE45 PROMT



CSE46 MEMO

COVER TYPES AND COLOURS

GROUP B VALENCIA BY SPRADLING



COVER TYPES AND COLOURS

GROUP B MAIN LINE FLAX BY CAMIRA



COVER TYPES AND COLOURS

GROUP B SILVETEX BY SPRADLING



COVER TYPES AND COLOURS

GROUP B MAGLIA BY SPRADLING



GROUP B

STAMSKIN ZEN BY SERGE FERRARI



STAMSKIN TOP BY SERGE FERRARI



GROUP B BATYLINE EDEN BY SERGE FERRARI



COVER TYPES AND COLOURS

NATTE BY SUNBRELLA



10022 GREY CHINE



10063 CHARCOAL CHINE



10152 GRAUMEL CHALK



OUTDOOR
USAGE

ETISILK

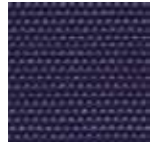

02183 PURPLE

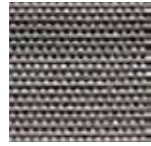

02709 MILK
BROWN



02306 BLUE

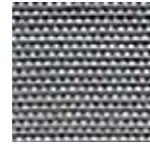

02631 GREY



OUTDOOR
USAGE

CHAIRS AND STOOLS

CHAIRS AND STOOLS

JOY COLLECTION

JOY-S

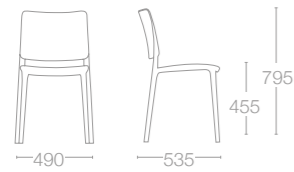

PP FINISH COLOURS

- 01 White
- 04 Red
- 09 Black
- 17 Warm Grey
- 22 Anthracite
- 61 Taupe
- 70 Aqua Blue
- 72 Orange

JOY-S Bar Stool / 75 CM

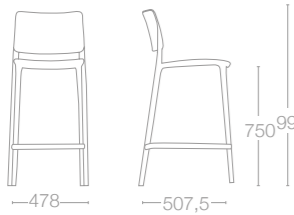

PP FINISH COLOURS

- 01 White
- 04 Red
- 17 Warm Grey
- 22 Anthracite
- 61 Taupe
- 70 Aqua Blue

JOY-S Bar Stool / 65 CM

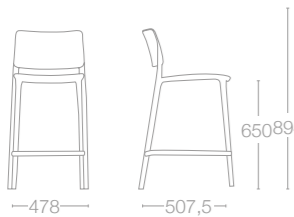

PP FINISH COLOURS

- 01 White
- 04 Red
- 17 Warm Grey
- 22 Anthracite
- 61 Taupe
- 70 Aqua Blue

JOY-K

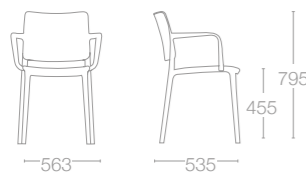

PP FINISH COLOURS

- 01 White
- 04 Red
- 09 Black
- 17 Warm Grey
- 22 Anthracite
- 61 Taupe
- 70 Aqua Blue
- 72 Orange

FAME-S

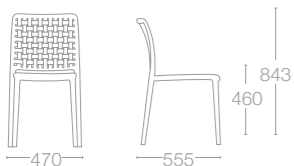

PP FINISH COLOURS

- 01 White
- 04 Red
- 22 Anthracite
- 61 Taupe
- 65 Sandy Beige

FAME-S Bar Stool / 75 CM

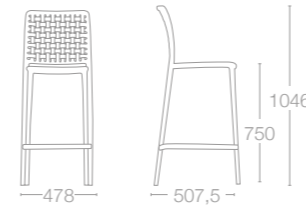

PP FINISH COLOURS

- 01 White
- 04 Red
- 22 Anthracite
- 61 Taupe

FAME-S Bar Stool / 65 CM

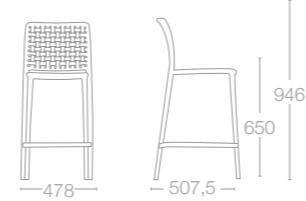

PP FINISH COLOURS

- 01 White
- 04 Red
- 22 Anthracite
- 61 Taupe

FAME-K

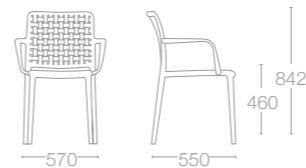

PP FINISH COLOURS

- 01 White
- 04 Red
- 22 Anthracite
- 61 Taupe

X'SERA

X'SERA-S

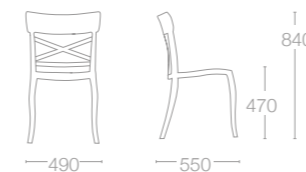

PP FINISH COLOURS

- 01 White
- 04 Red
- 65 Sandy Beige
- 67 Navy Blue
- 68 Canary Yellow
- 69 Reseda Green
- 70 Aqua Blue
- 71 Urban Bronze
- 72 Orange

TRIO

TRIO-S

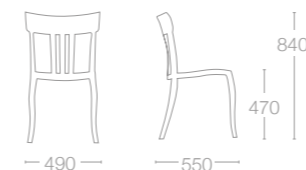

PP FINISH COLOURS

- 01 White
- 09 Black
- 22 Anthracite
- 61 Taupe
- 65 Sandy Beige

CHAIRS AND STOOLS

HERA COLLECTION

HERA-S

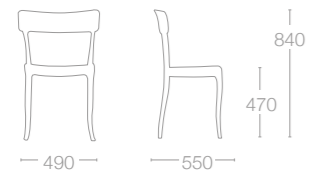

- SEAT: PP FINISH COLOURS
- 01 White
 - 09 Black
 - 22 Anthracite
 - 65 Sandy Beige

- BACK: PC GLOSSY FINISH (TRANSPARENT) COLOURS
- 29 Red
 - 33 Orange
 - 35 Green
 - 37 Clear
 - 38 Smoke

- BACK: PC GLOSSY FINISH (SOLID) COLOURS
- 42 Black
 - 43 White

HERA-K

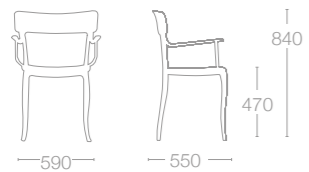

- SEAT: PP FINISH COLOURS
- 01 White
 - 09 Black
 - 22 Anthracite
 - 65 Sandy Beige

- BACK: PC GLOSSY FINISH (TRANSPARENT) COLOURS
- 28 Purple
 - 29 Red
 - 37 Clear
 - 38 Smoke
 - 40 Blue

- BACK: PC GLOSSY FINISH (SOLID) COLOURS
- 42 Black
 - 43 White

HERA-SP

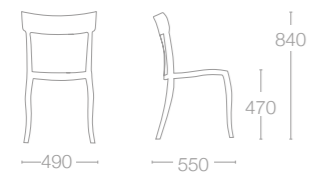

- PP FINISH COLOURS
- 01 White
 - 09 Black
 - 22 Anthracite
 - 61 Taupe
 - 65 Sandy Beige

HERA-SP Rattan

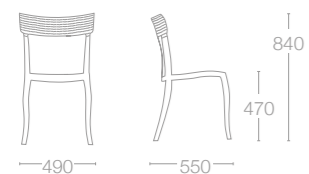

- PP FINISH COLOURS
- 01 White
 - 22 Anthracite
 - 53 Dark Brown
 - 65 Sandy Beige
 - 66 Storm Grey

TORO-S

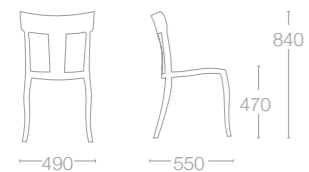

- PP FINISH COLOURS
- 01 White
 - 09 Black
 - 22 Anthracite
 - 61 Taupe
 - 65 Sandy Beige

TORO-S Rattan

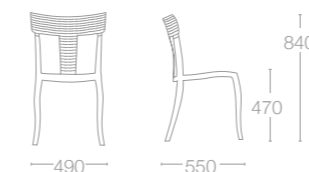

- PP FINISH COLOURS
- 01 White
 - 22 Anthracite
 - 53 Dark Brown
 - 65 Sandy Beige
 - 66 Storm Grey

LUNA

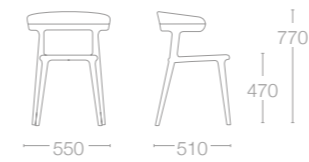

- SEAT: PP FINISH COLOURS
- 01 White
 - 09 Black
 - 22 Anthracite
 - 61 Taupe

- BACK: PC GLOSSY FINISH (TRANSPARENT) COLOURS
- 28 Purple
 - 29 Red
 - 33 Orange
 - 35 Green
 - 37 Clear
 - 38 Smoke
 - 40 Blue

- BACK: PC GLOSSY FINISH (SOLID) COLOURS
- 42 Black
 - 43 White

LUNA STRIPE



- PP FINISH COLOURS
- 01 White
 - 09 Black
 - 22 Anthracite
 - 61 Taupe

YUGO-S



- SEAT: PP FINISH COLOURS
- 01 White
 - 09 Black
 - 22 Anthracite
 - 69 Reseda Green

- FRAME COLOURS
- 106 Chrome plated
 - 101 White powder coated
 - 102 Black powder coated
 - 103 Anthracite powder coated
 - 112 Reseda Green powder coated

Powder coated (mat): Stregghned against rusting and scratches with cataphorensis application.

On request the base could be produced special paint applications; silver metallic

YUGO-S Bar Stool

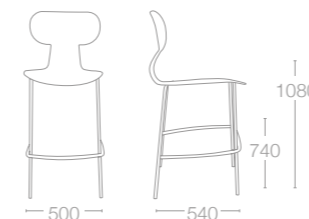

- SEAT: PP FINISH COLOURS
- 01 White
 - 09 Black
 - 22 Anthracite
 - 69 Reseda Green

- FRAME COLOURS
- 106 Chrome plated
 - 101 White powder coated
 - 102 Black powder coated
 - 103 Anthracite powder coated
 - 112 Reseda Green powder coated

Powder coated (mat): Stregghned against rusting and scratches with cataphorensis application.

On request the base could be produced special paint applications; silver metallic

HERA COLLECTION

TORO COLLECTION

LUNA COLLECTION

YUGO COLLECTION

CHAIRS AND STOOLS

YUGO COLLECTION

YUGO-S WOX



SEAT: PP FINISH COLOURS

- 01 White
- 09 Black
- 22 Anthracite
- 69 Reseda Green

WOODEN LEG FINISHES

- Natural beech wood
- Wenge lacquered beech wood
- Black lacquered beech wood
- White lacquered beech wood

METAL STRAPS FINISHES

Anthracite

On request the strap could be produced in with white (mat) finish. For not standards colours please check the price and delivery time.

O'PERA COLLECTION

O'PERA-S

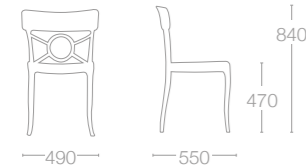

SEAT: PP FINISH COLOURS

- 01 White
- 09 Black
- 22 Anthracite

BACK: PC GLOSSY FINISH (TRANSPARENT) COLOURS

- 29 Red
- 37 Clear
- 38 Smoke

BACK: PC GLOSSY FINISH (SOLID) COLOURS

- 42 Black
- 43 White

EGO-K

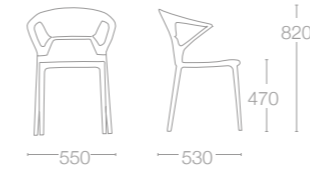

SEAT: PP FINISH COLOURS

- 01 White
- 09 Black
- 22 Anthracite

BACK: PC GLOSSY FINISH (TRANSPARENT) COLOURS

- 37 Clear
- 38 Smoke

BACK: PC GLOSSY FINISH (SOLID) COLOURS

- 42 Black

EGO-K Bar stool

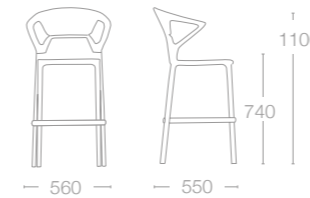

SEAT: PP FINISH COLOURS

- 01 White
- 09C Black
- 22C Anthracite

BACK: PC GLOSSY FINISH (TRANSPARENT) COLOURS

- 37 Clear
- 38 Smoke

BACK: PC GLOSSY FINISH (SOLID) COLOURS

- 42 Black

FRAME COLOURS

- Satin anodized aluminium
- White painted aluminium (mat)
- Black painted aluminium (mat)
- Anthracite painted aluminium (mat)

O'PERA-K

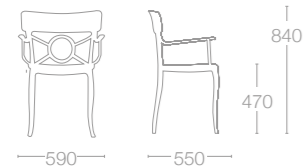

SEAT: PP FINISH COLOURS

- 01 White
- 09 Black
- 22 Anthracite

BACK: PC GLOSSY FINISH (TRANSPARENT) COLOURS

- 29 Red
- 37 Clear
- 38 Smoke

BACK: PC GLOSSY FINISH (SOLID) COLOURS

- 42 Black
- 43 White

EGO ROCK

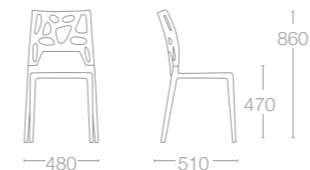

SEAT: PP FINISH COLOURS

- 01 White
- 09 Black
- 22 Anthracite

BACK: PC GLOSSY FINISH (TRANSPARENT) COLOURS

- 28 Purple
- 29 Red
- 33 Orange
- 35 Green
- 37 Clear
- 38 Smoke
- 40 Blue

BACK: PC GLOSSY FINISH (SOLID) COLOURS

- 42 Black
- 43 White
- 44 Red

EGO COLLECTION

EGO-S

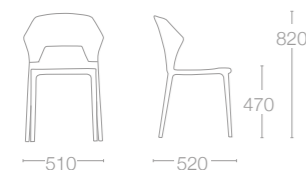

SEAT: PP FINISH COLOURS

- 01 White
- 09 Black
- 22 Anthracite

BACK: PC GLOSSY FINISH (TRANSPARENT) COLOURS

- 37 Clear
- 38 Smoke

BACK: PC GLOSSY FINISH (SOLID) COLOURS

- 42 Black

EGO ROCK Bar Stool

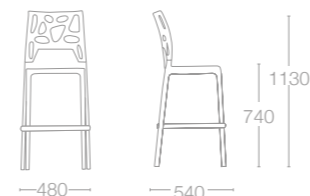

SEAT: PP FINISH COLOURS

- 01 White
- 09 Black
- 22 Anthracite

BACK: PC GLOSSY FINISH (TRANSPARENT) COLOURS

- 28 Purple
- 29 Red
- 33 Orange
- 35 Green
- 37 Clear
- 38 Smoke
- 40 Blue

BACK: PC GLOSSY FINISH (SOLID) COLOURS

- 42 Black
- 43 White
- 44 Red

FRAME COLOURS

- Satin anodized aluminium
- White painted aluminium (mat)
- Black painted aluminium (mat)
- Anthracite painted aluminium (mat)

EGO-S Bar Stool

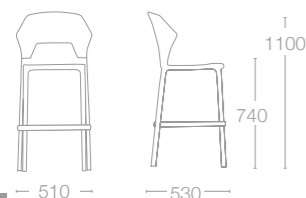

SEAT: PP FINISH COLOURS

- 01 White
- 09C Black
- 22C Anthracite

BACK: PC GLOSSY FINISH (TRANSPARENT) COLOURS

- 37 Clear
- 38 Smoke

BACK: PC GLOSSY FINISH (SOLID) COLOURS

- 42 Black

FRAME COLOURS

- Satin anodized aluminium
- White painted aluminium (mat)
- Black painted aluminium (mat)
- Anthracite painted aluminium (mat)

OPAL COLLECTION

OPAL-ML

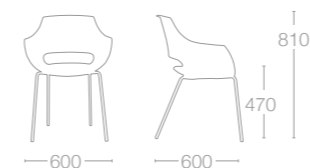

SEAT: PC GLOSSY FINISH (TRANSPARENT) COLOURS

- 35 Green
- 37 Clear
- 38 Smoke
- 40 Blue

SEAT: PC GLOSSY FINISH (SOLID) COLOURS

- 42 Black
- 43 White

FRAME COLOURS

chrome plated

on request: the base could be produced with outdoor resistant special paint applications. Powder coated (mat): **White, Anthracite, Black**

OPAL WOX With beech wood leg

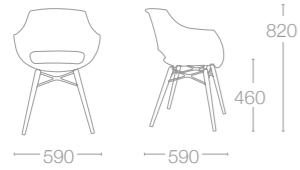

SEAT: PC GLOSSY FINISH (TRANSPARENT) COLOURS

- 35 Green
- 37 Clear
- 38 Smoke
- 40 Blue

SEAT: PC GLOSSY FINISH (SOLID) COLOURS

- 42 Black
- 43 White

WOODEN LEG FINISHES

- Natural beech wood
- Wenge lacquered beech wood
- Black lacquered beech wood
- White lacquered beech wood

METAL STRAPS FINISHES

- Anthracite

On request the strap could be produced in with white (mat) finish. For not standards colours please check the price and delivery time.

OPAL WOX With iroko wood leg

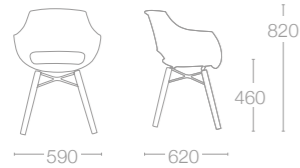

SEAT: PC GLOSSY FINISH (TRANSPARENT) COLOURS

- 35 Green
- 37 Clear
- 38 Smoke
- 40 Blue

SEAT: PC GLOSSY FINISH (SOLID) COLOURS

- 42 Black
- 43 White

WOODEN LEG FINISHES

- Natural iroko wood

(with colour stabilized oil treatment) Due to the nature of the iroko wood colour tone may differ in each purchase.

METAL STRAPS FINISHES

- Anthracite

On request the strap could be produced in with white (mat) finish. For not standards colours please check the price and delivery time.

OPAL-M

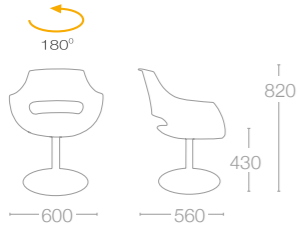

SEAT: PC GLOSSY FINISH (SOLID) COLOURS

- 42 Black
- 43 White

FRAME COLOURS

- Chrome plated

OPAL WOX PRO With beech wood leg



SEAT: PP FINISH COLOURS

- 01 White
- 09 Black
- 22 Anthracite
- 51 Brick Red
- 52 Dark Yellow
- 61 Taupe
- 69 Reseda Green

WOODEN LEG FINISHES

- Natural beech wood
- Wenge lacquered beech wood
- Black lacquered beech wood
- White lacquered beech wood

METAL STRAPS FINISHES

- Anthracite

On request the strap could be produced in with white (mat) finish. For not standards colours please check the price and delivery time.

OPAL WOX PRO With iroko wood leg

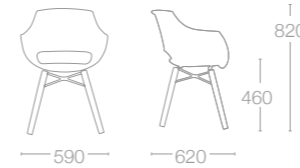

SEAT: PP FINISH COLOURS

- 01 White
- 09 Black
- 22 Anthracite
- 51 Brick Red
- 52 Dark Yellow
- 61 Taupe
- 69 Reseda Green

WOODEN LEG FINISHES

- Natural iroko wood

(with colour stabilized oil treatment) Due to the nature of the iroko wood colour tone may differ in each purchase.

METAL STRAPS FINISHES

- Anthracite

On request the strap could be produced in with white (mat) finish. For not standards colours please check the price and delivery time.

OPAL-M PRO

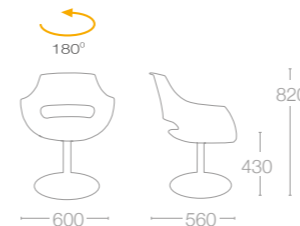

SEAT: PP FINISH COLOURS

- 01 White
- 09 Black
- 22 Anthracite
- 51 Brick Red
- 53 Dark Yellow
- 61 Taupe
- 69 Reseda Green

FRAME COLOURS

- Chrome plated

OPAL CHIEF

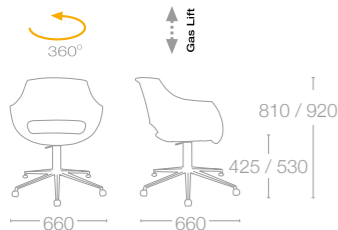

SEAT: PC GLOSSY FINISH (SOLID) COLOURS

- 42 Black
- 43 White

FRAME COLOURS

- Chrome plated

OPAL CHIEF PRO



SEAT: PP FINISH COLOURS

- 01 White
- 09 Black
- 22 Anthracite
- 51 Brick Red
- 52 Dark Yellow
- 61 Taupe
- 69 Reseda Green

FRAME COLOURS

- Chrome plated

OPAL-ML PRO

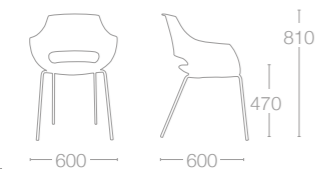

SEAT: PP FINISH COLOURS

- 01 White
- 09 Black
- 22 Anthracite
- 51 Brick Red
- 52 Dark Yellow
- 61 Taupe
- 69 Reseda Green

FRAME COLOURS

- 106 Chrome plated
- 101 White powder coated
- 102 Black powder coated
- 103 Anthracite powder coated
- 111 Brick Red powder coated
- 110 Dark Yellow powder coated
- 104 Taupe powder coated
- 112 Reseda Green powder coated

X-TREME-S

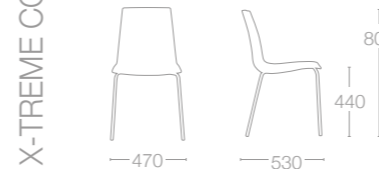

SEAT: PC GLOSSY FINISH (TRANSPARENT) COLOURS

- 29 Red
- 33 Orange
- 35 Green
- 37 Clear
- 38 Smoke

SEAT: PC GLOSSY FINISH (SOLID) COLOURS

- 42 Black
- 43 White
- 44 Red

FRAME COLOURS

- Chrome plated

on request: the base could be produced with outdoor resistant special paint applications. Powder coated (mat): **White, Anthracite, Black**

X-TREME-S WOX With beech wood leg

SEAT: PC GLOSSY FINISH (TRANSPARENT) COLOURS

- 29 Red
- 33 Orange
- 35 Green
- 37 Clear
- 38 Smoke

SEAT: PC GLOSSY FINISH (SOLID) COLOURS

- 42 Black
- 43 White
- 44 Red

WOODEN LEG FINISHES

- Natural beech wood
- Wenge lacquered beech wood
- Black lacquered beech wood
- White lacquered beech wood

METAL STRAPS FINISHES

- Anthracite

On request the strap could be produced in with white (mat) finish. For not standards colours please check the price and delivery time.

X-TREME-S WOX With iroko wood leg

SEAT: PC GLOSSY FINISH (TRANSPARENT) COLOURS

- 29 Red
- 33 Orange
- 35 Green
- 37 Clear
- 38 Smoke

SEAT: PC GLOSSY FINISH (SOLID) COLOURS

- 42 Black
- 43 White
- 44 Red

WOODEN LEG FINISHES

- Natural iroko wood (with colour stabilized oil treatment) Due to the nature of the iroko wood colour tone may differ in each purchase.

METAL STRAPS FINISHES

- Anthracite

On request the strap could be produced in with white (mat) finish. For not standards colours please check the price and delivery time.

X-TREME BSL

SEAT: PC GLOSSY FINISH (TRANSPARENT) COLOURS

- 29 Red
- 33 Orange
- 35 Green
- 37 Clear
- 38 Smoke

SEAT: PC GLOSSY FINISH (SOLID) COLOURS

- 42 Black
- 43 White
- 44 Red

FRAME COLOURS

- Chrome plated

on request: the base could be produced with outdoor resistant special paint applications. Powder coated (mat): **White, Anthracite, Black**

X-TREME BSS

SEAT: PC GLOSSY FINISH (TRANSPARENT) COLOURS

- 29 Red
- 33 Orange
- 35 Green
- 37 Clear
- 38 Smoke
- 40 Blue

SEAT: PC GLOSSY FINISH (SOLID) COLOURS

- 42 Black
- 43 White
- 44 Red

FRAME COLOURS

- Chrome plated

on request: the base could be produced with outdoor resistant special paint applications. Powder coated (mat): **White, Anthracite, Black**

X-TREME SLED

SEAT: PC GLOSSY FINISH (TRANSPARENT) COLOURS

- 29 Red
- 33 Orange
- 35 Green
- 37 Clear
- 38 Smoke
- 40 Blue

SEAT: PC GLOSSY FINISH (SOLID) COLOURS

- 42 Black
- 43 White
- 44 Red

FRAME COLOURS

- Chrome plated

on request: the base could be produced with outdoor resistant special paint applications. Powder coated (mat): **White, Anthracite, Black**

X-TREME B

SEAT: PC GLOSSY FINISH (TRANSPARENT) COLOURS

- 29 Red
- 33 Orange
- 35 Green
- 37 Clear
- 38 Smoke
- 40 Blue

SEAT: PC GLOSSY FINISH (SOLID) COLOURS

- 42 Black
- 43 White
- 44 Red

FRAME COLOURS

- Chrome plated

X-TREME BENCH With 2 seater & compact side table

SEAT: PC GLOSSY FINISH (TRANSPARENT) COLOURS

- 29 Red
- 33 Orange
- 35 Green
- 37 Clear
- 38 Smoke

SEAT: PC GLOSSY FINISH (SOLID) COLOURS

- 42 Black
- 43 White
- 44 Red

TABLE: COMPACT COLOURS

- 1049M Black
- 1050M White

FRAME COLOURS

- Chrome plated
- Anthracite powder coated
- Black powder coated
- White powder coated

X-TREME BENCH With 3 seater

SEAT: PC GLOSSY FINISH (TRANSPARENT) COLOURS

- 29 Red
- 33 Orange
- 35 Green
- 37 Clear
- 38 Smoke

SEAT: PC GLOSSY FINISH (SOLID) COLOURS

- 42 Black
- 43 White
- 44 Red

FRAME COLOURS

- Chrome plated
- Anthracite powder coated
- Black powder coated
- White powder coated

X-TREME BENCH With 3 seater & compact side table

SEAT: PC GLOSSY FINISH (TRANSPARENT) COLOURS

- 29 Red
- 33 Orange
- 35 Green
- 37 Clear
- 38 Smoke

SEAT: PC GLOSSY FINISH (SOLID) COLOURS

- 42 Black
- 43 White
- 44 Red

TABLE: COMPACT COLOURS

- 1049M Black
- 1050M White

FRAME COLOURS

- Chrome plated
- Anthracite powder coated
- Black powder coated
- White powder coated

X-TREME BENCH With 4 seater

SEAT: PC GLOSSY FINISH (TRANSPARENT) COLOURS

- 29 Red
- 33 Orange
- 35 Green
- 37 Clear
- 38 Smoke

SEAT: PC GLOSSY FINISH (SOLID) COLOURS

- 42 Black
- 43 White
- 44 Red

FRAME COLOURS

- Chrome plated
- Anthracite powder coated
- Black powder coated
- White powder coated

X-TREME BENCH With 4 seater & compact side table

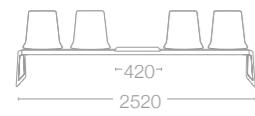

SEAT: PC GLOSSY FINISH (TRANSPARENT) COLOURS

- 29 Red
- 33 Orange
- 35 Green
- 37 Clear
- 38 Smoke

SEAT: PC GLOSSY FINISH (SOLID) COLOURS

- 42 Black
- 43 White
- 44 Red

TABLE: COMPACT COLOURS

- 1049M Black
- 1050M White

FRAME COLOURS

- Chrome plated
- Anthracite powder coated
- Black powder coated
- White powder coated

X-TREME-S PRO

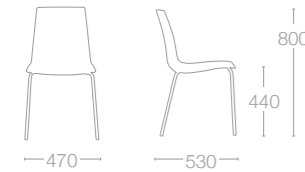

SEAT: PP FINISH COLOURS

- 01 White
- 09 Black
- 22 Anthracite
- 51 Brick Red
- 52 Dark Yellow
- 61 Taupe
- 69 Reseda Green

FRAME COLOURS

- 106 Chrome plated
- 101 White powder coated
- 102 Black powder coated
- 103 Anthracite powder coated
- 111 Brick Red powder coated
- 110 Dark Yellow powder coated
- 104 Taupe powder coated
- 112 Reseda Green powder coated

X-TREME-S WOX PRO With beech wood leg



SEAT: PP FINISH COLOURS

- 01 White
- 09 Black
- 22 Anthracite
- 51 Brick Red
- 52 Dark Yellow
- 61 Taupe
- 69 Reseda Green

WOODEN LEG FINISHES

- Natural beech wood
- Wenge lacquered beech wood
- Black lacquered beech wood
- White lacquered beech wood

METAL STRAPS FINISHES

- Anthracite

On request the strap could be produced in with white (mat) finish. For not standards colours please check the price and delivery time.

X-TREME-S WOX PRO With iroko wood leg

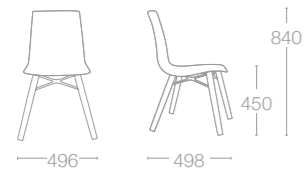

SEAT: PP FINISH COLOURS

- 01 White
- 09 Black
- 22 Anthracite
- 51 Brick Red
- 52 Dark Yellow
- 61 Taupe
- 69 Reseda Green

WOODEN LEG FINISHES

- Natural iroko wood
- (with colour stabilized oil treatment)
Due to the nature of the iroko wood colour tone may differ in each purchase.

METAL STRAPS FINISHES

- Anthracite

On request the strap could be produced in with white (mat) finish. For not standards colours please check the price and delivery time.

X-TREME BSL PRO

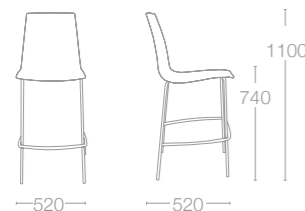

SEAT: PP FINISH COLOURS

- 01 White
- 09 Black
- 22 Anthracite
- 51 Brick Red
- 52 Dark Yellow
- 61 Taupe
- 69 Reseda Green

FRAME COLOURS

- 106 Chrome plated
- 101 White powder coated
- 102 Black powder coated
- 103 Anthracite powder coated
- 111 Brick Red powder coated
- 110 Dark Yellow powder coated
- 104 Taupe powder coated
- 112 Reseda Green powder coated

X-TREME BSS PRO

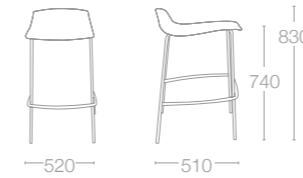

SEAT: PP FINISH COLOURS

- 01 White
- 09 Black
- 22 Anthracite
- 51 Brick Red
- 52 Dark Yellow
- 61 Taupe
- 69 Reseda Green

FRAME COLOURS

- 106 Chrome plated
- 101 White powder coated
- 102 Black powder coated
- 103 Anthracite powder coated
- 111 Brick Red powder coated
- 110 Dark Yellow powder coated
- 104 Taupe powder coated
- 112 Reseda Green powder coated

X-TREME SLED PRO

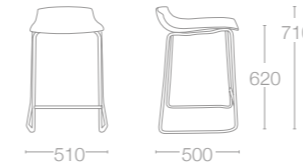

SEAT: PP FINISH COLOURS

- 01 White
- 09 Black
- 22 Anthracite
- 51 Brick Red
- 52 Dark Yellow
- 61 Taupe
- 69 Reseda Green

FRAME COLOURS

- 106 Chrome plated
- 101 White powder coated
- 102 Black powder coated
- 103 Anthracite powder coated
- 111 Brick Red powder coated
- 110 Dark Yellow powder coated
- 104 Taupe powder coated
- 112 Reseda Green powder coated

X-TREME B PRO



SEAT: PP FINISH COLOURS

- 01 White
- 09 Black
- 22 Anthracite
- 51 Brick Red
- 52 Dark Yellow
- 61 Taupe
- 69 Reseda Green

FRAME COLOURS

- Chrome plated

X-TREME BENCH With 2 seater & compact side table

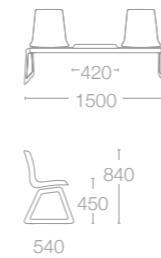

SEAT: PP FINISH COLOURS

- 01 White
- 09 Black
- 22 Anthracite
- 51 Brick Red
- 52 Dark Yellow
- 61 Taupe
- 69 Reseda Green

TABLE: COMPACT COLOURS

- 1049M Black
- 1050M White

FRAME COLOURS

- Chrome plated
- Anthracite powder coated
- Black powder coated
- White powder coated

X-TREME BENCH With 3 seater

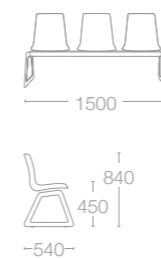

SEAT: PP FINISH COLOURS

- 01 White
- 09 Black
- 22 Anthracite
- 51 Brick Red
- 52 Dark Yellow
- 61 Taupe
- 69 Reseda Green

FRAME COLOURS

- Chrome plated
- Anthracite powder coated
- Black powder coated
- White powder coated

CHAIRS AND STOOLS

X-TREME BENCH PRO With 3 seater & compact side table

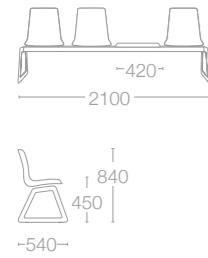

- SEAT: PP FINISH COLOURS
- 01 White
 - 09 Black
 - 22 Anthracite
 - 51 Brick Red
 - 52 Dark Yellow
 - 61 Taupe
 - 69 Reseda Green

- TABLE: COMPACT COLOURS
- 1049M Black
 - 1050M White

- FRAME COLOURS
- Chrome plated
 - Anthracite powder coated
 - Black powder coated
 - White powder coated

X-TREME BENCH PRO With 4 seater

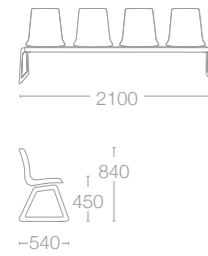

- SEAT: PP FINISH COLOURS
- 01 White
 - 09 Black
 - 22 Anthracite
 - 51 Brick Red
 - 52 Dark Yellow
 - 61 Taupe
 - 69 Reseda Green

- FRAME COLOURS
- Chrome plated
 - Anthracite powder coated
 - Black powder coated
 - White powder coated

X-TREME BENCH With 4 seater & compact side table

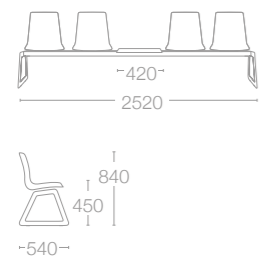

- SEAT: PP FINISH COLOURS
- 01 White
 - 09 Black
 - 22 Anthracite
 - 51 Brick Red
 - 52 Dark Yellow
 - 61 Taupe
 - 69 Reseda Green

- TABLE: COMPACT COLOURS
- 1049M Black
 - 1050M White

- FRAME COLOURS
- Chrome plated
 - Anthracite powder coated
 - Black powder coated
 - White powder coated

FLORA CHIEF

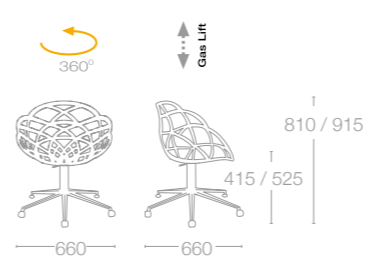

- FULLY: PP AND PC MAT FINISH COLOURS
- 01C White
 - 09C Black
 - 22C Anthracite
 - 51C Brick Red

- SEAT: PC GLOSSY FINISH (TRANSPARENT) COLOURS
- 28 Purple
 - 29 Red
 - 37 Clear
 - 38 Smoke
 - 40 Blue
 - 50 Light Orange

- SEAT: PC GLOSSY FINISH (SOLID) COLOURS
- 43 White

- FRAME COLOURS
- Chrome plated

GYZA

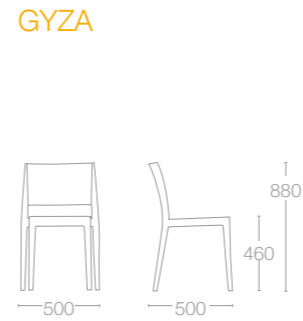

- PC GLOSSY FINISH (TRANSPARENT) COLOURS
- 29 Red
 - 35 Green
 - 37 Clear
 - 38 Smoke
 - 40 Blue

- PC GLOSSY FINISH (SOLID) COLOURS
- 42 Black
 - 43 White
 - 44 Red

CLASS-X

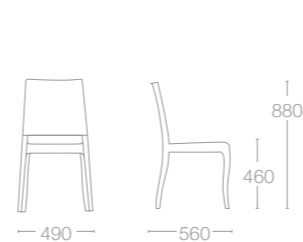

- PC GLOSSY FINISH (TRANSPARENT) COLOURS
- 37 Clear
 - 38 Smoke

- PC GLOSSY FINISH (SOLID) COLOURS
- 42 Black
 - 43 White

CLASS-XC

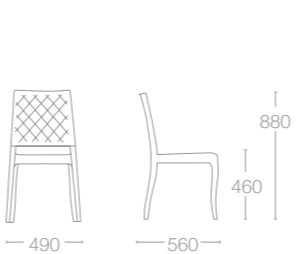

- PC GLOSSY FINISH (TRANSPARENT) COLOURS
- 37 Clear
 - 38 Smoke

FLORA COLLECTION

FLORA-PP

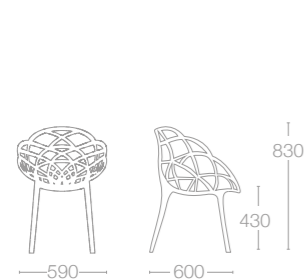

- FULLY: PP AND PC MAT FINISH COLOURS
- 01C White
 - 09C Black
 - 22C Anthracite
 - 51C Brick Red

- SEAT: PC GLOSSY FINISH (TRANSPARENT) COLOURS
- 28 Purple
 - 29 Red
 - 37 Clear
 - 38 Smoke
 - 40 Blue
 - 50 Light Orange

- SEAT: PC GLOSSY FINISH (SOLID) COLOURS
- 43 White

- LEGS: PP FINISH COLOURS
- 01 White
 - 09C Black
 - 22 Anthracite

FLORA-ML

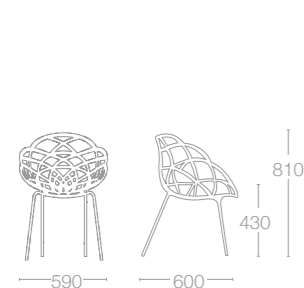

- FULLY: PP AND PC MAT FINISH COLOURS
- 01C White
 - 09C Black
 - 22C Anthracite
 - 51C Brick Red

- SEAT: PC GLOSSY FINISH (TRANSPARENT) COLOURS
- 28 Purple
 - 29 Red
 - 37 Clear
 - 38 Smoke
 - 40 Blue
 - 50 Light Orange

- SEAT: PC GLOSSY FINISH (SOLID) COLOURS
- 43 White

- FRAME COLOURS
- Chrome plated
- on request: the base could be produced with outdoor resistant special paint applications. Powder coated (mat): **White, Anthracite, Black Brick Red**

EDEN COLLECTION

EDEN-S

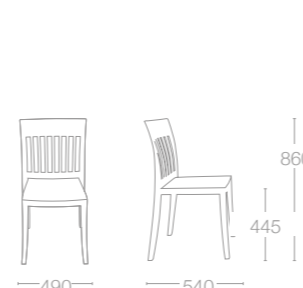

- PP MAT FINISH COLOURS
- 22 Anthracite
 - 51C Brick Red

- PP FINISH COLOURS
- 01 White
 - 17 Warm grey
 - 22 Anthracite
 - 52 Dark Yellow
 - 61 Taupe

CHAIRS AND STOOLS

EDEN COLLECTION

EDEN-K

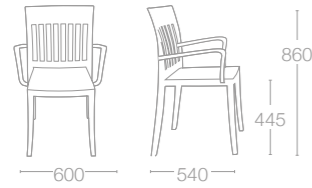

PP MAT FINISH COLOURS

- 22 Anthracite
- 51C Brick Red

PP FINISH COLOURS

- 01 White
- 17 Warm grey
- 22 Anthracite
- 52 Dark Yellow
- 61 Taupe

MAMBO

MAMBO

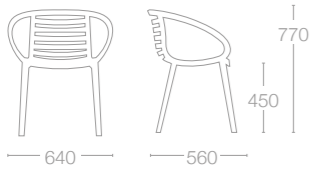

PP FINISH COLOURS

- 01 White
- 22 Anthracite
- 61 Taupe

COOL

COOL

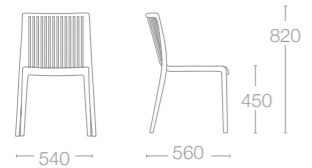

PP FINISH COLOURS

- 01 White
- 04 Red
- 22 Anthracite
- 23 Purple
- 24 Green
- 25 Blue
- 61 Taupe

NOSTA

NOSTA-S

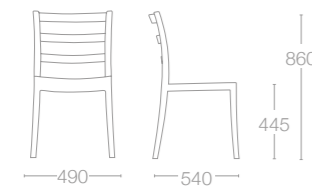

PP FINISH COLOURS

- 01 White
- 17 Warm grey
- 22 Anthracite
- 61 Taupe
- 70 Aqua Blue

VARIA

VARIA-S

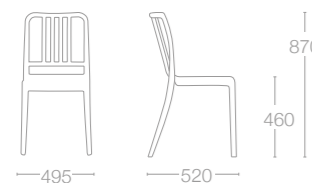

PP MAT FINISH COLOURS

- 04C Red
- 22C Anthracite

PP FINISH COLOURS

- 01 White
- 04 Red
- 17 Warm grey
- 22 Anthracite
- 65 Sandy Beige
- 54 Lime Green
- 61 Taupe

YUMMY

YUMMY

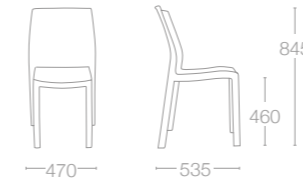

PP FINISH COLOURS

- 01 White
- 04 Red
- 05 Dark Green
- 09 Black
- 13 Teak
- 72 Orange
- 21 Ivory

TIARA

TIARA

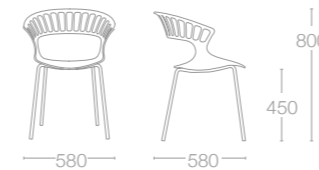

SEAT: PP FINISH COLOURS

- 01 White
- 04 Red
- 22 Anthracite
- 23 Purple

FRAME COLOURS

- Chrome plated
- Anthracite powder coated
- White powder coated

ICON COLLECTION

ICON-S

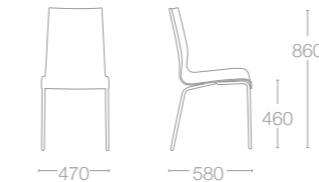

SEAT: PP FINISH COLOURS

- 01 White
- 04 Red
- 09 Black
- 21 Ivory
- 22 Anthracite

FRAME COLOURS

- Chrome plated
- Silver metallic

ICON-B

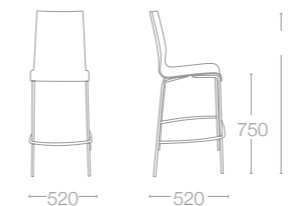

SEAT: PP FINISH COLOURS

- 01 White
- 04 Red
- 09 Black
- 21 Ivory
- 22 Anthracite

FRAME COLOURS

- Chrome plated
- Silver metallic

ICON-K



SEAT: PP FINISH COLOURS

- 01 White
- 04 Red
- 09 Black
- 21 Ivory
- 22 Anthracite

FRAME COLOURS

- Chrome plated

CHAIRS AND STOOLS

VITAL COLLECTION

VITAL-S

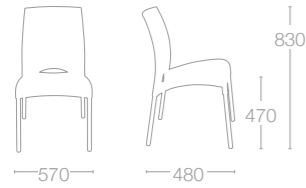

SEAT: PP FINISH COLOURS

- 21 Ivory
- 72 Orange

FRAME COLOURS

- Satin Anodized Aluminium

VITAL-K

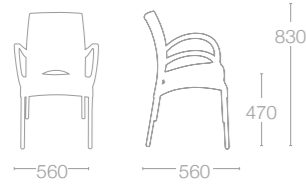

SEAT: PP FINISH COLOURS

- 01 White
- 09 Black
- 21 Ivory
- 12 Light Green

FRAME COLOURS

- Satin Anodized Aluminium

MARVEL-S

MARVEL-S

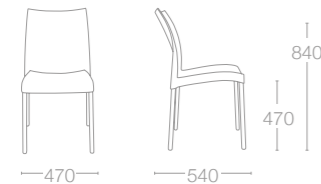

SEAT: PP FINISH COLOURS

- 04 Red
- 09 Black
- 12 Light Green
- 21 Ivory
- 72 Orange

FRAME COLOURS

- Satin Anodized Aluminium

KAREA

KAREA

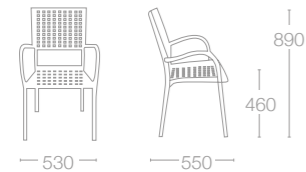

SEAT: PP FINISH COLOURS

- 01 White
- 04 Red
- 05 Dark Green
- 09 Black
- 13 Teak
- 16 Orange
- 21 Ivory

FRAME COLOURS

- Satin Anodized Aluminium

WAVE COLLECTION

WAVE SUNLOUNGER

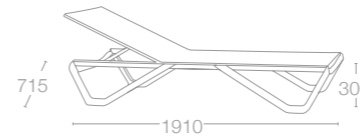

BASE: PP FINISH COLOURS

- 01 White
- 22 Anthracite
- 61 Taupe

FABRIC COLOURS

- 05001 White
- 05700 Anthracite
- 050070 Taupe
- 05374 Grey
- 05017 Yellow
- 05347 Turquoise

FRAME COLOURS

- Satin anodized aluminium

WAVE SIDE TABLE

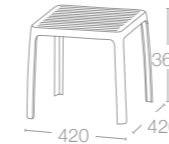

PP FINISH COLOURS

- 01 White
- 22 Anthracite
- 61 Taupe

ZEN COLLECTION

ZEN SUNLOUNGER

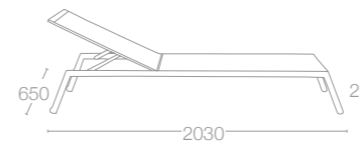

FABRIC COLOURS

- 05001 White
- 05700 Anthracite

FRAME COLOURS

- Stainless steel

ZEN SIDE TABLE

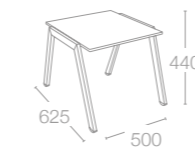

COMPACT TABLE TOP COLOURS

- 1050M White
- 1049M Black

FRAME COLOURS

- Stainless steel

CHAIRS AND STOOLS COLOURS

PP FINISH COLOURS



PP MATT FINISH COLOURS

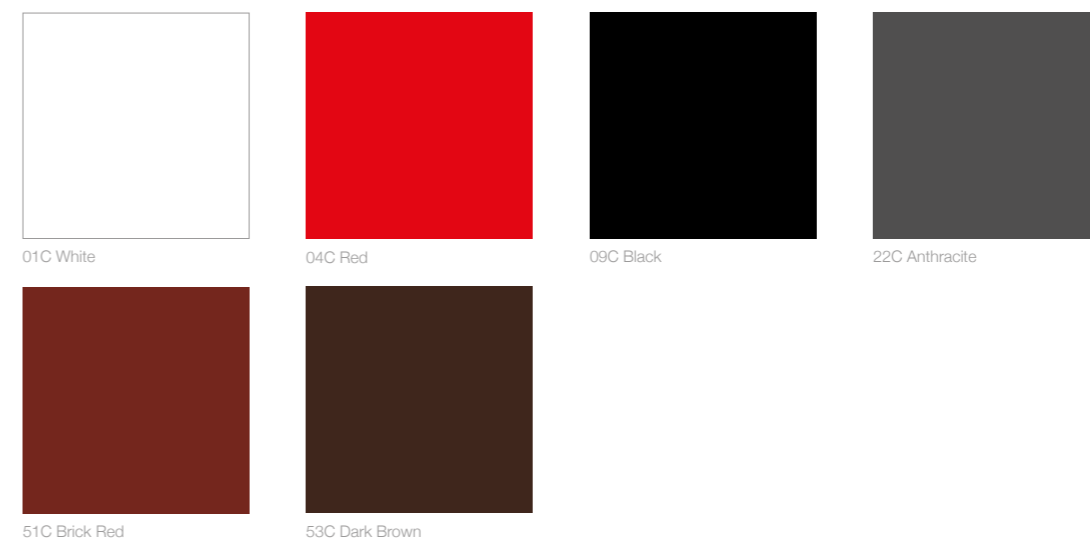

PC GLOSSY FINISH (TRANSPARENT) COLOURS

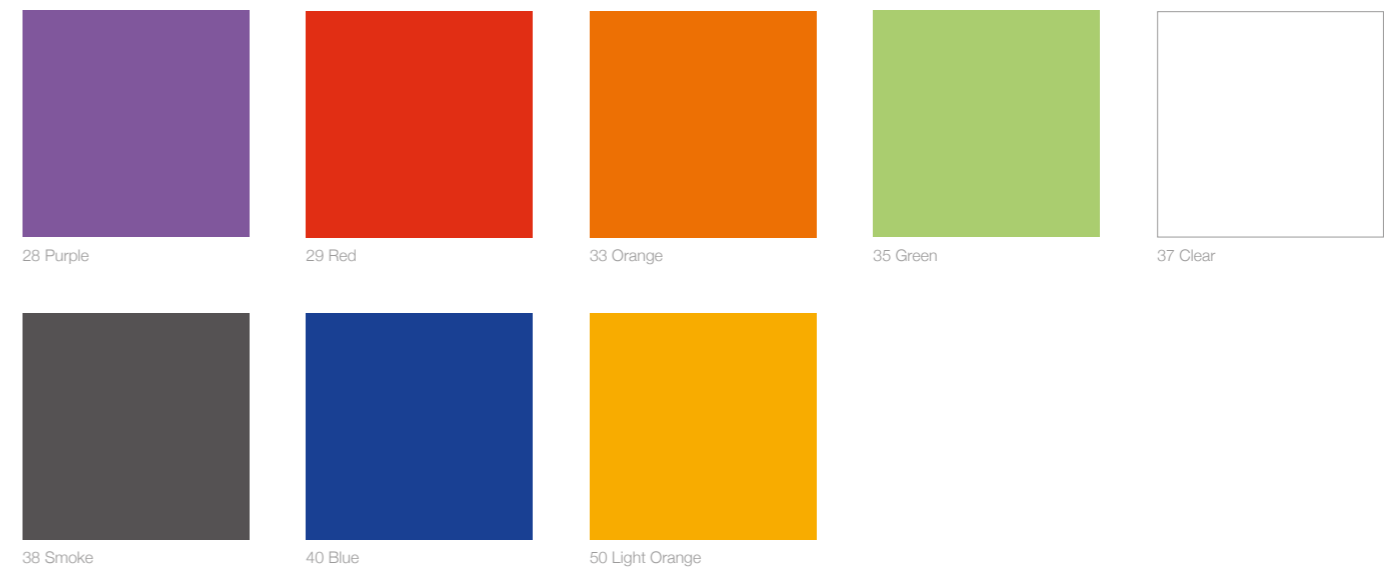

CHAIRS AND STOOLS COLOURS

PC GLOSSY FINISH (SOLID) COLOURS



42 Black

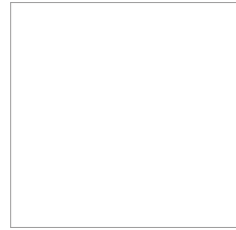

43 White



44 Red

PC MAT FINISH COLOURS

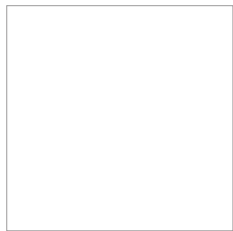

01C White

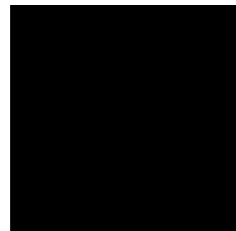

09C Black



22C Anthracite



51C Brick Red



52C Dark Yellow

SOFAS

SOFAS

LOCA COLLECTION

LS 01

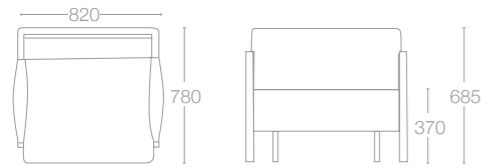

METAL FINISH COLOURS

- 101 White
- 103 Anthracite
- 104 Taupe

FABRIC FINISH COLOURS

ETISILK

- 02183 Purple
- 02709 M. Brown
- 02306 Blue
- 02631 Grey

BATYLINE EDEN

- 00566 L.Grey
- 00555 Anthracite
- 00563 Beige
- 50974 Orange
- 50967 Green

LS 02

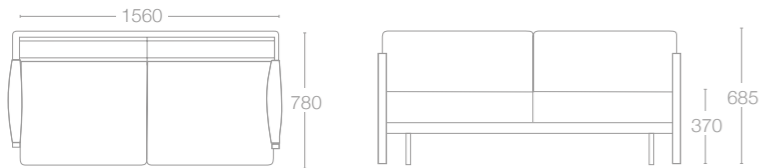

METAL FINISH COLOURS

- 101 White
- 103 Anthracite
- 104 Taupe

FABRIC FINISH COLOURS

ETISILK

- 02183 Purple
- 02709 M. Brown
- 02306 Blue
- 02631 Grey

BATYLINE EDEN

- 00566 L.Grey
- 00555 Anthracite
- 00563 Beige
- 50974 Orange
- 50967 Green

LS 03

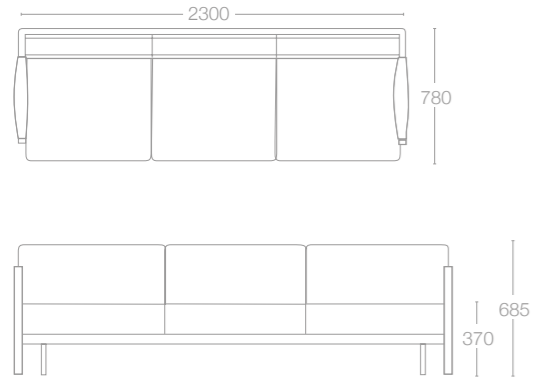

METAL FINISH COLOURS

- 101 White
- 103 Anthracite
- 104 Taupe

FABRIC FINISH COLOURS

ETISILK

- 02183 Purple
- 02709 M. Brown
- 02306 Blue
- 02631 Grey

BATYLINE EDEN

- 00566 L.Grey
- 00555 Anthracite
- 00563 Beige
- 50974 Orange
- 50967 Green

LS 3+1

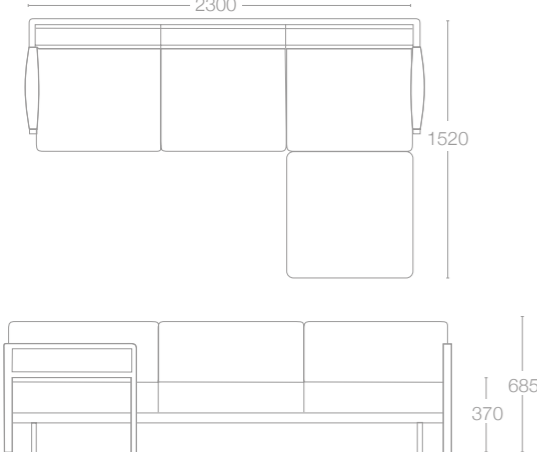

METAL FINISH COLOURS

- 101 White
- 103 Anthracite
- 104 Taupe

FABRIC FINISH COLOURS

ETISILK

- 02183 Purple
- 02709 M. Brown
- 02306 Blue
- 02631 Grey

BATYLINE EDEN

- 00566 L.Grey
- 00555 Anthracite
- 00563 Beige
- 50974 Orange
- 50967 Green

LOCA COLLECTION

LS 3+2

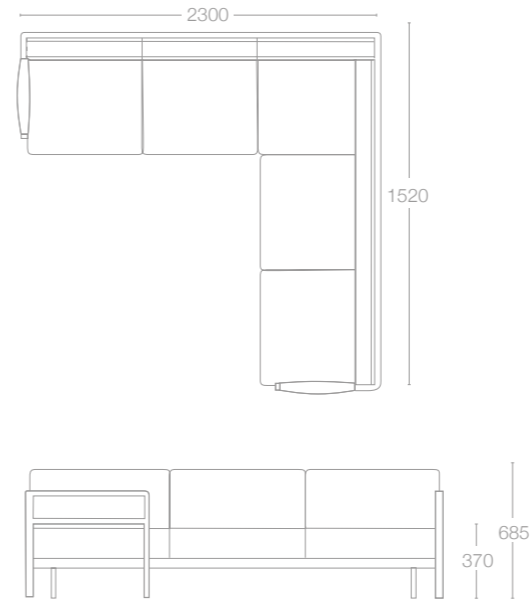

METAL FINISH COLOURS

- 101 White
- 103 Anthracite
- 104 Taupe

FABRIC FINISH COLOURS

ETISILK

- 02183 Purple
- 02709 M. Brown
- 02306 Blue
- 02631 Grey

BATYLINE EDEN

- 00566 L.Grey
- 00555 Anthracite
- 00563 Beige
- 50974 Orange
- 50967 Green

LS 3+3

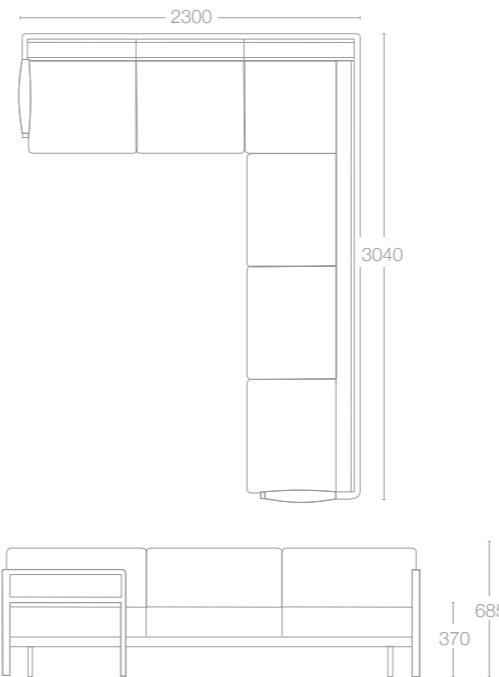

METAL FINISH COLOURS

- 101 White
- 103 Anthracite
- 104 Taupe

FABRIC FINISH COLOURS

ETISILK

- 02183 Purple
- 02709 M. Brown
- 02306 Blue
- 02631 Grey

BATYLINE EDEN

- 00566 L.Grey
- 00555 Anthracite
- 00563 Beige
- 50974 Orange
- 50967 Green

PUF LP 550X550

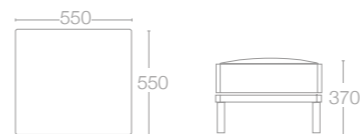

PUF LP 740X740

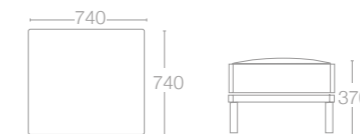

METAL FINISH COLOURS

- 101 White
- 103 Anthracite
- 104 Taupe

FABRIC FINISH COLOURS

ETISILK

- 02183 Purple
- 02709 M. Brown
- 02306 Blue
- 02631 Grey

BATYLINE EDEN

- 00566 L.Grey
- 00555 Anthracite
- 00563 Beige
- 50974 Orange
- 50967 Green

LOCA COLLECTION

RECTANGULAR SIDE TABLE

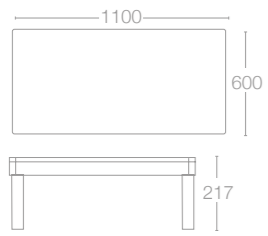

SQUARE SIDE TABLE

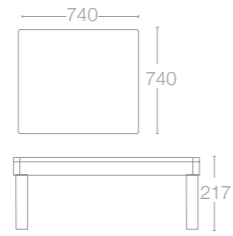

METAL FINISH COLOURS

- 101 White
- 103 Anthracite
- 104 Taupe

SOLID LAMINATE COMPACT TOP COLOURS:
1050M, 1049M, 3039M, 3120M
5101STN, 1057M, 5056M

SLIM COLLECTION

MAIN MODULE

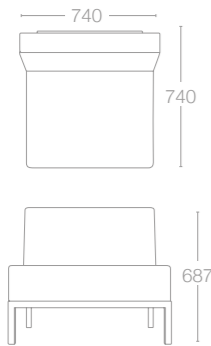

CORNER MODULE

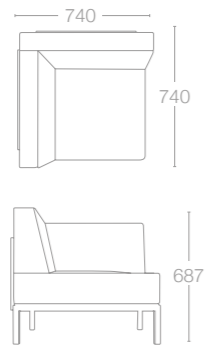

ALUMINIUM BASE FINISH COLOURS

- 101 White
- 103 Anthracite
- 104 Taupe
- 113 Brass

FABRIC FINISH COLOURS

ETISILK

- 02183 Purple
- 02709 M. Brown
- 02306 Blue
- 02631 Grey

BATYLINE EDEN

- 00566 L.Grey
- 00555 Anthracite
- 00563 Beige

- 50974 Orange
- 50967 Green

ARMREST

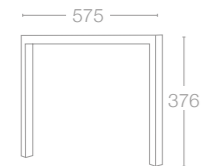

STAINLESS STEEL FINISH COLOURS

- 101 White
- 103 Anthracite
- 104 Taupe
- 113 Brass

CENTER LOW TABLE

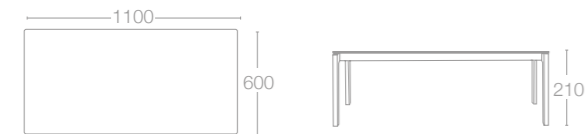

ALUMINIUM BASE FINISH COLOURS

- 101 White
- 103 Anthracite
- 104 Taupe
- 113 Brass

SIDE TABLE

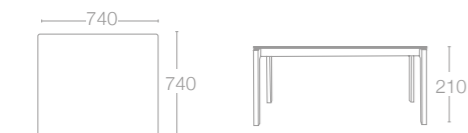

SOLID LAMINATE COMPACT TOP COLOURS:
1050M, 1049M, 3039M, 3120M
5101STN, 1057M, 5056M

TABLES

WOX beech legs

- WOODEN LEG FINISHES
- Natural beech wood
 - Wenge lacquered beech wood
 - Black lacquered beech wood
 - White lacquered beech wood

- METAL STRAP FINISHES
- Anthracite

On request the strap could be produced in **white or black** (mat) finish. For non standarts colours please check the prices and delivery time.

AVAILABLE TOP COLOURS
1050M, 1049M, 1057M, 3039M, 1049WGR1, 3120M, 5101STN, 5056M

Solid laminate compact top colours on page 280
Except white, other colours are recommended only in shaded areas

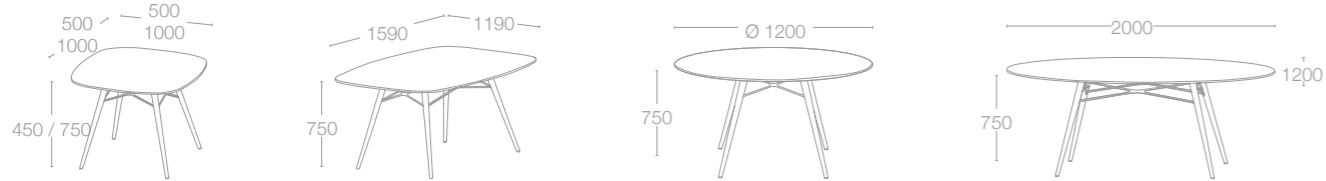

| SIZE | LEGS | TOP INCLUDED (12MM) | Kg. |
|----------------------|---------------|---------------------|---------|
| 1000 x 1000 x H. 750 | Ø 32 wood leg | ✓ | Kg 19,2 |
| 1190 x 1590 x H. 750 | Ø 32 wood leg | ✓ | Kg 34,4 |
| Ø 1200 x H. 750 | Ø 32 wood leg | ✓ | Kg 22,9 |
| 1200 x 2000 x H. 750 | Ø 32 wood leg | ✓ | Kg 34,1 |
| 500 x 500 x H. 450 | Ø 32 wood leg | ✓ | Kg 6 |

WOX iroko legs

- WOODEN LEG FINISHES
- Natural iroko wood

(with colour stabilized oil treatment) Due to the nature of the iroko wood colour tone may differ in each purchase.

- Anthracite

On request the strap could be produced in (mat) finish. For non standarts colours please check the prices and delivery time.

AVAILABLE TOP COLOURS
1050M, 1049M, 1057M, 3039M, 1049WGR1, 3120M, 5101STN, 5056M

Solid laminate compact top colours on page 280
Except white, other colours are recommended only in shaded areas



| SIZE | LEGS | TOP INCLUDED (12MM) | Kg. |
|----------------------|------------------|---------------------|---------|
| 1000 x 1000 x H. 750 | 30 x 30 wood leg | ✓ | Kg 19,2 |
| 1190 x 1590 x H. 750 | 30 x 30 wood leg | ✓ | Kg 34,4 |
| Ø 1200 x H. 750 | 30 x 30 wood leg | ✓ | Kg 22,9 |
| 1200 x 2000 x H. 750 | 30 x 30 wood leg | ✓ | Kg 34,1 |
| 500 x 500 x H. 450 | 30 x 30 wood leg | ✓ | Kg 6 |

MAXIMA

- FRAME FINISH
- chrome plated

- 101 White
102 Black
103 Anthracite
104 Taupe
115 Grey
- Electrostatic powder coated metal table bases are strengthened by cataphoresis application.

AVAILABLE TOP COLOURS
1050M, 1049M, 1057M, 3039M, 1049WGR1, 3120M, 5101STN, 5056M

Solid laminate compact top colours on page 280
Except white, other colours are recommended only in shaded areas



| SIZE | FRAME | TOP INCLUDED (12MM) | Kg. |
|----------------------|---------|---------------------|---------|
| 900 x 900 x H. 750 | 50 x 50 | ✓ | Kg 34,5 |
| 1800 x 900 x H. 750 | 50 x 50 | ✓ | Kg 53,5 |
| 2200 x 1000 x H. 750 | 50 x 50 | ✓ | Kg 67 |

OPUS with polymer laminate top (18 mm) or solid laminate top (12 mm)

- FRAME FINISH
- satin anodized aluminium

AVAILABLE TOP FINISHES

POLYMER LAMINATE MDF TOP COLOURS:
74 Gold, 76 yellow, 77 Black, 79 Pear, 81 Cream, 83 White, 84 Grey, 86 D. walnut, 87 Maple, 89 Wenge, 90 Claret, 91 orange, 93 Walnut, 96 Cherry, 99 D. cherry

SOLID LAMINATE COMPACT TOP COLOURS:
1050M, 1049M, 3039M, 1057M

Polymer laminate mdf top colours on page 281
Solid laminate compact top colours on page 280
Except white, other colours are recommended only in shaded areas

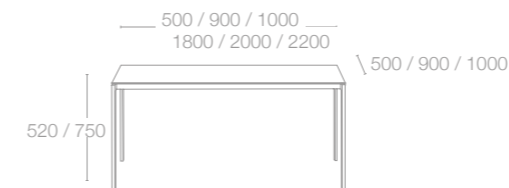

| SIZE | FRAME | TOP INCLUDED | Kg. |
|----------------------|---------|--------------|----------------------------------|
| 900 x 900 x H. 750 | 50 x 50 | ✓ | Kg 19,5 (mdf) Kg 23 (compact) |
| 900 x 1800 x H. 750 | 50 x 50 | ✓ | Kg 33 (mdf) Kg 39 (compact) |
| 1000 x 2000 x H. 750 | 50 x 50 | ✓ | Kg 38,5 (mdf) Kg 46 (compact) |
| 1000 x 2200 x H. 750 | 50 x 50 | ✓ | Kg 41,5 (mdf) Kg 50 (compact) |
| 500 x 500 x H. 520 | 50 x 50 | ✓ | Kg 10,5 (mdf) Kg 11 (compact) |
| 500 x 1000 x H. 520 | 50 x 50 | ✓ | Kg 14 (mdf) Kg 16 (compact) |

TABLES

IDEA with polymer laminate top (18 mm) or solid laminate top (12 mm)

FRAME FINISHES

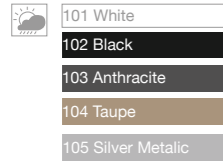

Electrostatic powder coated metal table bases are strengthened by cataphoresis application.

AVAILABLE TOP FINISHES

POLIMER LAMINATE MDF TOP COLOURS:

74 Gold, 76 yellow, 77 Black, 79 Pear, 81 Cream, 83 White, 84 Grey, 86 D. walnut, 87 Maple, 89 Wenge, 90 Claret, 91 orange, 93 Walnut, 96 Cherry, 99 D. cherry

SOLID LAMINATE COMPACT TOP COLOURS:

1050M, 1049M, 3039M, 3120M, 5101STN, 1057M, 5056M

Polymer laminate mdf top colours on page 281
Solid laminate compact top colours on page 280

Except white, other colours are recommended only in shaded areas

| SIZE | FRAME | TOP INCLUDED | Kg. |
|---------------------|---------|--------------|------------------------------------|
| 800 x 800 x H. 750 | 40 x 40 | ✓ | Kg 21,5 (mdf) Kg 23 (compact) |
| 800 x 1200 x H. 750 | 40 x 40 | ✓ | Kg 23,5 (mdf) Kg 26,5 (compact) |
| 800 x 1400 x H. 750 | 40 x 40 | ✓ | Kg 30,5 (mdf) Kg 34,5 (compact) |
| 500 x 500 x H. 520 | 40 x 40 | ✓ | Kg 9,5 (mdf) Kg 10 (compact) |
| 500 x 1000 x H. 520 | 40 x 40 | ✓ | Kg 13,5 (mdf) Kg 15,5 (compact) |

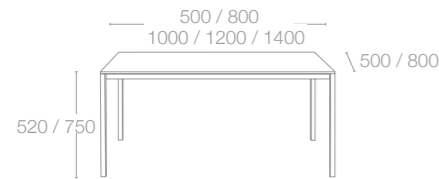

SLIM with polymer laminate top (18 mm), solid laminate top (12 mm)

FRAME FINISHES

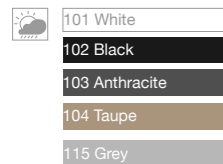

Electrostatic powder coated metal table bases are strengthened by cataphoresis application.

AVAILABLE TOP FINISHES

POLIMER LAMINATE MDF TOP COLOURS:

74 Gold, 76 yellow, 77 Black, 79 Pear, 81 Cream, 83 White, 84 Grey, 86 D. walnut, 87 Maple, 89 Wenge, 90 Claret, 91 orange, 93 Walnut, 96 Cherry, 99 D. cherry

SOLID LAMINATE COMPACT TOP COLOURS:

1050M, 1049M, 3039M, 1049WGR1, 3120M, 5101STN, 1057M, 5056M

Polymer laminate mdf top colours on page 281
Solid laminate compact top colours on page 280

Except white, other colours are recommended only in shaded areas

| SIZE | FRAME | TOP INCLUDED | Kg. |
|---------------------|---------|--------------|------------------------------------|
| 800 x 800 x H. 750 | 30 x 30 | ✓ | Kg 21,5 (mdf) Kg 24 (compact) |
| 800 x 1200 x H. 750 | 30 x 30 | ✓ | Kg 27,5 (mdf) Kg 30 (compact) |
| 800 x 1400 x H. 750 | 30 x 30 | ✓ | Kg 30,5 (mdf) Kg 33,5 (compact) |
| 500 x 500 x H. 520 | 30 x 30 | ✓ | Kg 12 (mdf) Kg 13 (compact) |
| 500 x 1000 x H. 520 | 30 x 30 | ✓ | Kg 17 (mdf) Kg 19 (compact) |

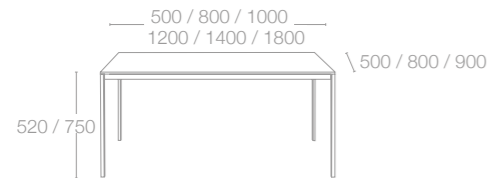

ONIX round with solid laminate top (12 mm)

FRAME FINISHES

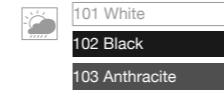
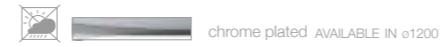

Electrostatic powder coated metal table bases are strengthened by cataphoresis application.

AVAILABLE TOP COLOURS

1050M, 1049M, 3039M, 1049WGR1, 3120M, 5101STN, 1057M, 5056M

Ø 1590 x H. 750 AVAILABLE ONLY IN COMPACT TABLE TOP COLOURS: 1050M, 1049M, 3039M, 3120M, 5101STN, 1057M

Solid laminate compact top colours on page 280

Except white, other colours are recommended only in shaded areas

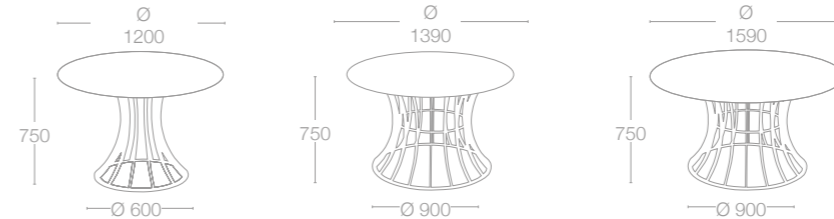

| SIZE | BASE | TOP INCLUDED | Kg. |
|-----------------|-------|--------------|-------------------|
| Ø 1200 x H. 750 | Ø 600 | ✓ | Kg 41,5 (compact) |
| Ø 1390 x H. 750 | Ø 600 | ✓ | Kg 62,5 (compact) |
| Ø 1590 x H. 750 | Ø 900 | ✓ | Kg 70,9 (compact) |

TRIO DOUBLE with solid laminate top (12 mm)

FRAME FINISHES

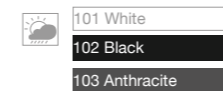

Electrostatic powder coated metal table bases are strengthened by cataphoresis application.

AVAILABLE TOP FINISHES

1050M, 1049M, 3039M, 1049WGR1, 3120M, 5101STN, 1057M, 5056M

Solid laminate compact top colours on page 280

Except white, other colours are recommended only in shaded areas

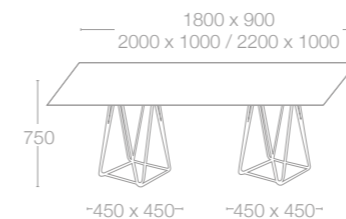

| SIZE | BASE | TOP INCLUDED | Kg. |
|----------------------|----------------|--------------|-------------------|
| 900 x 1800 x H. 750 | 450 x 450 (x2) | ✓ | Kg 41 (compact) |
| 1000 x 2000 x H. 750 | 450 x 450 (x2) | ✓ | Kg 48,5 (compact) |
| 1000 x 2200 x H. 750 | 450 x 450 (x2) | ✓ | Kg 52 (compact) |

TABLE BASES

TABLE BASES

PLUS COLLECTION

PLUS

With adjustable foot

BASE FINISH 

| | |
|----------------|-----------------|
| 101 White | 110 Dark Yellow |
| 102 Black | 111 Brick Red |
| 103 Anthracite | 112 R. Green |
| 104 Taupe | 115 Grey |

Electrostatic powder coated metal table bases are strengthened by cataphoresis application.

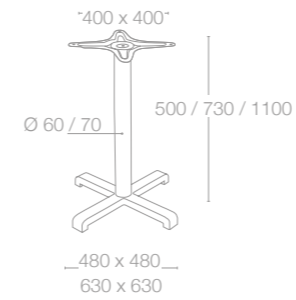

| MODEL | BASE | FOOT | TOP SUPPORT | APPLICABLE TABLE TOP MAXIMUM RECOMMENDED SIZE | Kg. |
|---------------------------|-----------|-----------------|-------------|---|----------|
| 480 x 480 table base | 480 x 480 | H. 730 Ø 60 | 400 x 400 | square 700 x 700 round Ø 700 | Kg. 5,50 |
| 480 x 480 side table base | 480x480 | H.500 Ø 60 | 400x400 | square 700x700 round Ø 700 | Kg. 5,00 |
| 630 x 630 table base | 630 x 630 | H. 730 Ø 70 | 400 x 400 | square 800 x 800 round Ø 800 | Kg. 6,40 |
| 630 x 630 bar table base | 630 x 630 | H. 1100 Ø 70 | 400 x 400 | square 700 x 700 round Ø 700 | Kg. 7,00 |

PLUS COLLECTION

PLUS II

With adjustable foot

BASE FINISH 

| | |
|----------------|-----------------|
| 101 White | 110 Dark Yellow |
| 102 Black | 111 Brick Red |
| 103 Anthracite | 112 R. Green |
| 104 Taupe | 115 Grey |

Electrostatic powder coated metal table bases are strengthened by cataphoresis application.

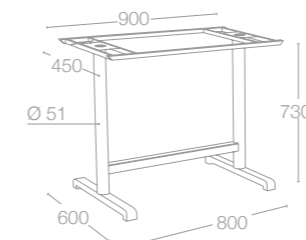

| MODEL | BASE | FOOT | TOP SUPPORT | APPLICABLE TABLE TOP MAXIMUM RECOMMENDED SIZE | Kg. |
|----------------------|-----------|----------------|-------------|---|--------|
| 600 x 800 table base | 600 x 800 | H. 730 Ø 51 | 450 x 900 | 800 x 1400 | Kg. 11 |

TABLE BASES

KROSS COLLECTION

KROSS

With adjustable foot

BASE FINISH 

- 101 White 110 Dark Yellow
- 102 Black 111 Brick Red
- 103 Anthracite 112 R. Green
- 104 Taupe 115 Grey

Electrostatic powder coated metal table bases are strengthened by cathaphoresis application.

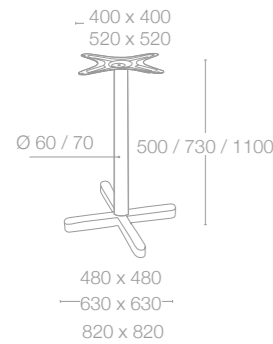

| MODEL | BASE | FOOT | TOP SUPPORT | APPLICABLE TABLE TOP MAXIMUM RECOMMENDED SIZE | Kg. |
|---------------------------|-----------|-----------------|-------------|---|---------|
| 480 x 480 table base | 480 x 480 | H. 730 Ø 60 | 400 x 400 | square 700 x 700 round Ø 700 | Kg. 6 |
| 480 x 480 side table base | 480 x 480 | H. 500 Ø 60 | 400 x 400 | square 700 x 700 round Ø 700 | Kg. 5 |
| 630 x 630 table base | 630 x 630 | H. 730 Ø 70 | 400 x 400 | square 800 x 800 round Ø 800 | Kg. 6,5 |
| 630 x 630 bar table base | 630 x 630 | H. 1100 Ø 70 | 400 x 400 | square 700 x 700 round Ø 700 | Kg. 7,5 |
| 820 x 820 table base | 820 x 820 | H. 730 Ø 70 | 520 x 520 | square 900 x 900 round Ø 1000 | Kg. 11 |

KROSS II

With adjustable foot

BASE FINISH 

- 101 White 110 Dark Yellow
- 102 Black 111 Brick Red
- 103 Anthracite 112 R. Green
- 104 Taupe 115 Grey

Electrostatic powder coated metal table bases are strengthened by cathaphoresis application.

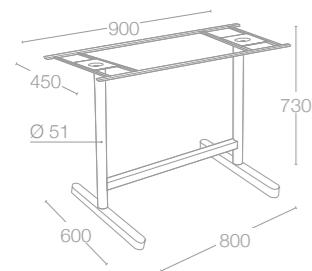

| MODEL | BASE | FOOT | TOP SUPPORT | APPLICABLE TABLE TOP MAXIMUM RECOMMENDED SIZE | Kg. |
|----------------------|-----------|----------------|-------------|---|--------|
| 600 x 800 table base | 600 x 800 | H. 730 Ø 51 | 450 x 900 | 800 x 1400 | Kg. 11 |

OXO COLLECTION

OXO I

With adjustable foot

BASE FINISH 

- 101 White 110 Dark Yellow
- 102 Black 111 Brick Red
- 103 Anthracite 112 R. Green
- 104 Taupe 115 Grey

Electrostatic powder coated metal table bases are strengthened by cathaphoresis application.

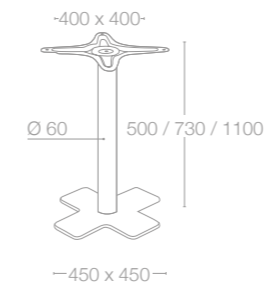

| MODEL | BASE | FOOT | TOP SUPPORT | APPLICABLE TABLE TOP MAXIMUM RECOMMENDED SIZE | Kg. |
|---------------------------|-----------|-----------------|-------------|---|----------|
| 450 x 450 table base | 450 x 450 | H. 730 Ø 60 | 400 x 400 | square 700 x 700 round Ø 800 | Kg. 10,5 |
| 450 x 450 bar table base | 450 x 450 | H. 1100 Ø 60 | 400 x 400 | square 600 x 600 round Ø 600 | Kg. 11,5 |
| 450 x 450 side table base | 450 x 450 | H. 500 Ø 60 | 400 x 400 | square 700 x 700 round Ø 800 | Kg. 9,5 |

OXO II

With adjustable foot

BASE FINISH 

- 101 White 110 Dark Yellow
- 102 Black 111 Brick Red
- 103 Anthracite 112 R. Green
- 104 Taupe 115 Grey

Electrostatic powder coated metal table bases are strengthened by cathaphoresis application.

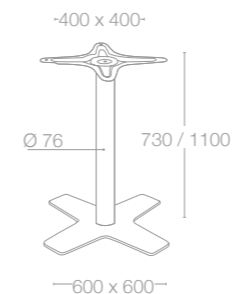

| MODEL | BASE | FOOT | TOP SUPPORT | APPLICABLE TABLE TOP MAXIMUM RECOMMENDED SIZE | Kg. |
|--------------------------|-----------|-----------------|-------------|---|----------|
| 600 x 600 table base | 600 x 600 | H. 730 Ø 76 | 520 x 520 | square 900 x 900 round Ø 900 | Kg. 13 |
| 600 x 600 bar table base | 600 x 600 | H. 1100 Ø 76 | 400 x 400 | square 700 x 700 round Ø 700 | Kg. 14,5 |

TABLE BASES

LOTUS COLLECTION

LOTUS SQUARE

With adjustable foot

| BASE FINISH | |
|-----------------|--------------|
| 101 White | 112 R. Green |
| 102 Black | 115 Grey |
| 103 Anthracite | 113 Brass |
| 104 Taupe | 114 Copper |
| 110 Dark Yellow | |
| 111 Brick Red | |

Electrostatic powder coated metal table bases are strengthened by cathoporesis application.

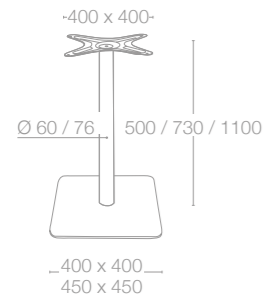

| MODEL | BASE | FOOT | TOP SUPPORT | APPLICABLE TABLE TOP MAXIMUM RECOMMENDED SIZE | Kg. |
|---------------------------|-----------|-----------------|-------------|--|----------|
| 400 x 400 table base | 400 x 400 | H. 730 Ø 60 | 400 x 400 | square 700 x 700 round Ø 800 | Kg. 13,5 |
| 400 x 400 bar table base | 400 x 400 | H. 1100 Ø 60 | 400 x 400 | square 600 x 600 round Ø 600 | Kg. 14,5 |
| 400 x 400 side table base | 400 x 400 | H. 500 Ø 60 | 400 x 400 | square 700 x 700 round Ø 800 | Kg. 12,5 |
| 450 x 450 table base | 450 x 450 | H. 730 Ø 76 | 520 x 520 | square 800 x 800 round Ø 900 | Kg. 17 |
| 450 x 450 bar table base | 450 x 450 | H. 1100 Ø 76 | 400 x 400 | square 700 x 700 round Ø 700 | Kg. 17,5 |

LOTUS COLLECTION

LOTUS SQUARE

With adjustable foot

| BASE FINISH | |
|-----------------|--------------|
| 101 White | 112 R. Green |
| 102 Black | 115 Grey |
| 103 Anthracite | 113 Brass |
| 104 Taupe | 114 Copper |
| 110 Dark Yellow | |
| 111 Brick Red | |

Electrostatic powder coated metal table bases are strengthened by cathoporesis application.

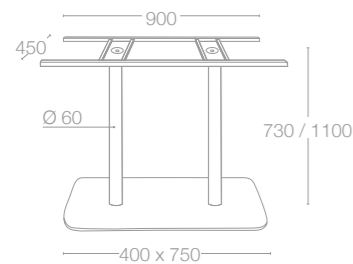

| MODEL | BASE | FOOT | TOP SUPPORT | APPLICABLE TABLE TOP MAXIMUM RECOMMENDED SIZE | Kg. |
|--------------------------|-----------|-----------------|-------------|--|----------|
| 400 x 750 table base | 400 x 750 | H. 730 Ø 60 | 450 x 900 | 800 x 1400 | Kg. 26,5 |
| 400 x 750 bar table base | 400 x 750 | H. 1100 Ø 60 | 450 x 900 | 700 x 1100 | Kg. 28 |

LOTUS ROUND

With adjustable foot

| BASE FINISH | |
|-----------------|--------------|
| 101 White | 112 R. Green |
| 102 Black | 115 Grey |
| 103 Anthracite | 113 Brass |
| 104 Taupe | 114 Copper |
| 110 Dark Yellow | |
| 111 Brick Red | |

Electrostatic powder coated metal table bases are strengthened by cathoporesis application.

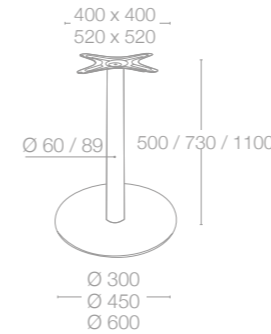

| MODEL | BASE | FOOT | TOP SUPPORT | APPLICABLE TABLE TOP MAXIMUM RECOMMENDED SIZE | Kg. |
|-----------------------|-------|-----------------|-------------|--|--------|
| Ø 300 side table base | Ø 300 | H. 500 Ø 60 | 400 x 400 | square 700 x 700 round Ø 700 | Kg. 7 |
| Ø 450 table base | Ø 450 | H. 730 Ø 60 | 400 x 400 | square 800 x 800 round Ø 900 | Kg. 13 |
| Ø 450 bar table base | Ø 450 | H. 1100 Ø 60 | 400 x 400 | square 700 x 700 round Ø 700 | Kg. 14 |
| Ø 450 side table base | Ø 450 | H. 500 Ø 60 | 400 x 400 | square 800 x 800 round Ø 900 | Kg. 12 |
| Ø 600 table base | Ø 600 | H. 730 Ø 89 | 520 x 520 | square 900 x 900 round Ø 1200 | Kg. 28 |

MODUS

With adjustable foot

| BASE FINISH (COORDINATE) | |
|--------------------------|-----------------------|
| FOOT | BASE |
| 107 Brushed stainless | 107 Brushed stainless |
| 106 Chrome plated | 107 Brushed stainless |
| 105 Silver metallic | 107 Brushed stainless |

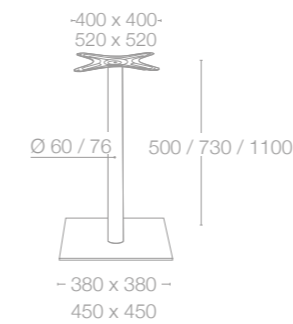

| MODEL | BASE | FOOT | TOP SUPPORT | APPLICABLE TABLE TOP MAXIMUM RECOMMENDED SIZE | Kg. |
|---------------------------|-----------|-----------------|-------------|--|----------|
| 380 x 380 table base | 380 x 380 | H. 730 Ø 60 | 400 x 400 | square 700 x 700 round Ø 800 | Kg. 14,5 |
| 380 x 380 bar table base | 380 x 380 | H. 1100 Ø 60 | 400 x 400 | square 700 x 700 round Ø 700 | Kg. 15,5 |
| 380 x 380 side table base | 380 x 380 | H. 500 Ø 60 | 400 x 400 | square 700 x 700 round Ø 800 | Kg. 13,5 |
| 450 x 450 table base | 450 x 450 | H. 730 Ø 76 | 520 x 520 | square 900 x 900 round Ø 1000 | Kg. 17,5 |

TABLE BASES

MODUS II

With adjustable foot

BASE FINISH (COORDINATE)

| FOOT | BASE |
|-----------------------|-----------------------|
| 107 Brushed stainless | 107 Brushed stainless |
| 106 Chrome plated | 107 Brushed stainless |
| 105 Silver metallic | 107 Brushed stainless |

| MODEL | BASE | FOOT | TOP SUPPORT | APPLICABLE TABLE TOP MAXIMUM RECOMMENDED SIZE | Kg. |
|--------------------------|-----------|-----------------|-------------|--|----------|
| 380 x 760 table base | 380 x 760 | H. 730 Ø 60 | 450 x 900 | square 700 x 1100 | Kg. 28 |
| 380 x 760 bar table base | 380 x 760 | H. 1100 Ø 60 | 450 x 900 | square 700 x 1100 | Kg. 30 |
| 450 x 900 table base | 450 x 900 | H. 730 Ø 76 | 450 x 900 | square 800 x 1400 | Kg. 35,5 |

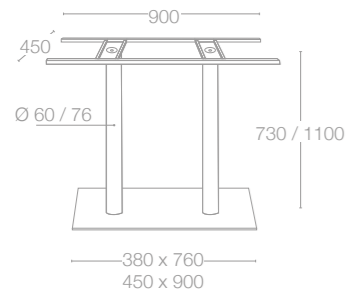

PUNTO

With adjustable foot

BASE FINISH (COORDINATE)

| FOOT | BASE |
|-----------------------|-----------------------|
| 107 Brushed stainless | 107 Brushed stainless |
| 106 Chrome plated | 107 Brushed stainless |
| 105 Silver metallic | 107 Brushed stainless |

| MODEL | BASE | FOOT | TOP SUPPORT | APPLICABLE TABLE TOP MAXIMUM RECOMMENDED SIZE | Kg. |
|-----------------------|-------|-----------------|-------------|--|----------|
| Ø 300 side table base | Ø 300 | H. 500 Ø 60 | 400 x 400 | square 700 x 700 round Ø 700 | Kg. 8 |
| Ø 450 table base | Ø 450 | H. 730 Ø 60 | 400 x 400 | square 800 x 800 round Ø 900 | Kg. 14,5 |
| Ø 450 bar table base | Ø 450 | H. 1100 Ø 60 | 400 x 400 | square 700 x 700 round Ø 700 | Kg. 15 |
| Ø 450 side table base | Ø 450 | H. 500 Ø 60 | 400 x 400 | square 700 x 700 round Ø 800 | Kg. 13,5 |
| Ø 550 table base | Ø 600 | H. 730 Ø 76 | 520 x 520 | square 900 x 900 round Ø 1100 | Kg. 24 |

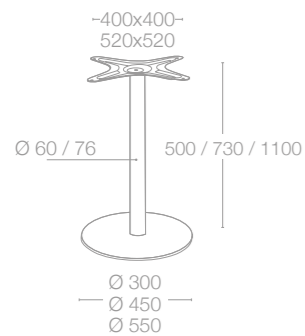

SPARK

BASE FINISH

| | |
|----------------|-----------------|
| 101 White | 110 Dark Yellow |
| 102 Black | 111 Brick Red |
| 103 Anthracite | 112 R. Green |
| 104 Taupe | 115 Grey |

Electrostatic powder coated metal table bases are strengthened by cathaphoresis application.

BASE FINISH

106 Chrome plated

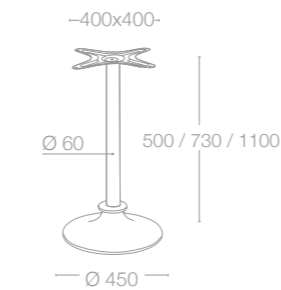

GAMA

GAMA

With adjustable foot

BASE FINISH

106 Chrome plated

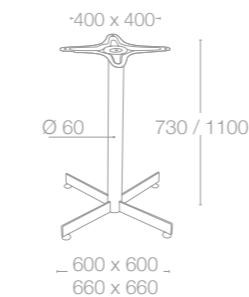

| MODEL | BASE | FOOT | TOP SUPPORT | APPLICABLE TABLE TOP MAXIMUM RECOMMENDED SIZE | Kg. |
|-----------------------|-------|-----------------|-------------|--|---------|
| Ø 450 table base | Ø 450 | H. 730 Ø 60 | 400 x 400 | square 800 x 800 round Ø 900 | Kg. 8,5 |
| Ø 450 bar table base | Ø 450 | H. 1100 Ø 60 | 400 x 400 | square 700 x 700 round Ø 700 | Kg. 9,5 |
| Ø 450 side table base | Ø 450 | H. 730 Ø 60 | 400 x 400 | square 800 x 800 round Ø 900 | Kg. 7,5 |

| MODEL | BASE | FOOT | TOP SUPPORT | APPLICABLE TABLE TOP MAXIMUM RECOMMENDED SIZE | Kg. |
|--------------------------|-----------|-----------------|-------------|--|---------|
| 600 x 600 table base | 600 x 600 | H. 730 Ø 60 | 400 x 400 | square 700 x 700 round Ø 800 | Kg. 7,5 |
| 600 x 600 bar table base | 600 x 600 | H. 1100 Ø 60 | 400 x 400 | square 700 x 700 round Ø 700 | Kg. 8,5 |
| 660 x 660 table base | 660 x 660 | H. 730 Ø 60 | 400 x 400 | square 800 x 800 round Ø 900 | Kg. 8 |

SOLID COMPACT TABLE TOPS

EDGE TYPES:



| SHAPE | SIZE | TOP TYPES | | | |
|-------------|------------|--|---------|-------|----------|
| | | 1050M - 1049M - 1057M - 3039M 3169M - 3177M - 3120M | 5101STN | 5056M | 1049WGR1 |
| Round | Ø 500 | ✓ | ✓ | ✓ | ✓ |
| Round | Ø 600 | ✓ | ✓ | ✓ | ✓ |
| Round | Ø 700 | ✓ | ✓ | ✓ | ✓ |
| Round | Ø 800 | ✓ | ✓ | ✓ | ✓ |
| Round | Ø 900 | ✓ | ✓ | ✓ | ✓ |
| Round | Ø 1000 | ✓ | ✓ | ✓ | ✓ |
| Round | Ø 1200 | ✓ | ✓ | ✓ | ✓ |
| Square | 500 x 500 | ✓ | ✓ | ✓ | ✓ |
| Square | 600 x 600 | ✓ | ✓ | ✓ | ✓ |
| Square | 700 x 700 | ✓ | ✓ | ✓ | ✓ |
| Square | 800 x 800 | ✓ | ✓ | ✓ | ✓ |
| Square | 900 x 900 | ✓ | ✓ | ✓ | ✓ |
| Rectangular | 500 x 1000 | ✓ | ✓ | ✓ | ✓ |
| Rectangular | 700 x 1100 | ✓ | ✓ | ✓ | ✓ |
| Rectangular | 700 x 1200 | ✓ | ✓ | ✓ | ✓ |
| Rectangular | 800 x 1200 | ✓ | ✓ | ✓ | ✓ |
| Rectangular | 800 x 1400 | ✓ | ✓ | ✓ | ✓ |

Except white, other colours are recommended only in shades areas

Table top colours on page 280 - 281

On request, table tops can be produced in different sizes and colours. Please contact with our sales team.

SOLID COMPACT CENTRE BASE TABLE TOPS

EDGE TYPES: flat edge 12mm

| SHAPE | SIZE | TOP TYPES | | | |
|-------------|----------------------|--|---------|-------|----------|
| | | 1050M - 1049M - 1057M - 3039M 3169M - 3177M - 3120M | 5101STN | 5056M | 1049WGR1 |
| Round | Ø490 | ✓ | ✓ | ✓ | ✓ |
| Round | Ø590 | ✓ | ✓ | ✓ | ✓ |
| Round | Ø690 | ✓ | ✓ | ✓ | ✓ |
| Round | Ø790 | ✓ | ✓ | ✓ | ✓ |
| Round | Ø890 | ✓ | ✓ | ✓ | ✓ |
| Round | Ø990 | ✓ | ✓ | ✓ | ✓ |
| Round | Ø1190 | ✓ | ✓ | ✓ | ✓ |
| Round | Ø1390 | ✓ | ✓ | ✓ | — |
| Round | Ø1590 | ✓ | ✓ | — | — |
| Square | 490x490 | ✓ | ✓ | ✓ | ✓ |
| Square | 590x590 | ✓ | ✓ | ✓ | ✓ |
| Square | 690x690 | ✓ | ✓ | ✓ | ✓ |
| Square | 790x790 | ✓ | ✓ | ✓ | ✓ |
| Square | 890x890 | ✓ | ✓ | ✓ | ✓ |
| Square | 990x990 | ✓ | ✓ | ✓ | ✓ |
| Regtengular | 590x690 | ✓ | ✓ | ✓ | ✓ |
| Regtengular | 690x790 | ✓ | ✓ | ✓ | ✓ |
| Regtengular | 690x1090 | ✓ | ✓ | ✓ | ✓ |
| Regtengular | 690x1190 | ✓ | ✓ | ✓ | ✓ |
| Regtengular | 690x1390 | ✓ | ✓ | ✓ | ✓ |
| Regtengular | 790x1190 790x1390 | ✓ | ✓ | ✓ | ✓ |
| Regtengular | 790x1590 | ✓ | ✓ | ✓ | ✓ |

POLIMER LAMINATED MDF CORE TABLE TOPS

COLOUR TYPES:



| SHAPE | SIZE | EDGE TYPES | | | | |
|-------------|------------|-----------------|------------------|--------------------------|--------------------|--------------------------|
| | | flat edge 18 | bevel edge 18 | reverse bevel edge 18 | reverse bevel edge | demi bullnose edge 25 |
| Square | 500 x 500 | ✓ | — | — | — | ✓ |
| Square | 600 x 600 | — | ✓ | — | — | ✓ |
| Square | 700 x 700 | — | ✓ | — | — | ✓ |
| Square | 800 x 800 | ✓ | ✓ | — | — | ✓ |
| Square | 900 x 900 | ✓ | ✓ | — | — | ✓ |
| Round | Ø 600 | — | ✓ | ✓ | ✓ | — |
| Round | Ø 700 | — | ✓ | ✓ | ✓ | — |
| Round | Ø 800 | — | ✓ | ✓ | ✓ | — |
| Round | Ø 900 | — | ✓ | ✓ | ✓ | — |
| Round | Ø 1000 | — | ✓ | ✓ | ✓ | — |
| Round | Ø 1100 | — | ✓ | ✓ | ✓ | — |
| Rectangular | 500 x 1000 | ✓ | — | — | — | ✓ |
| Rectangular | 700 x 1100 | — | ✓ | — | — | ✓ |
| Rectangular | 800 x 1200 | ✓ | ✓ | — | — | ✓ |
| Rectangular | 800 x 1400 | ✓ | ✓ | — | — | ✓ |
| Rectangular | 900 x 1800 | — | — | — | — | ✓ |

Table top colours on page 280 - 281

On request, table tops can be produced in different sizes and colours. Please contact with our sales team.

LAMINATED CHIPBOARD TOPS WITH ABS EDGE

COLOUR TYPES:

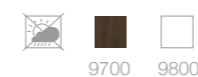

| SHAPE | SIZE | EDGE TYPES | | | | |
|-------------|------------|-----------------|-----------------|--|--|--|
| | | flat edge 18 | flat edge 30 | | | |
| Square | 600 x 600 | ✓ | ✓ | | | |
| Square | 700 x 700 | ✓ | ✓ | | | |
| Square | 800 x 800 | ✓ | ✓ | | | |
| Square | 900 x 900 | ✓ | ✓ | | | |
| Round | Ø 600 | ✓ | ✓ | | | |
| Round | Ø 700 | ✓ | ✓ | | | |
| Round | Ø 800 | ✓ | ✓ | | | |
| Round | Ø 900 | ✓ | ✓ | | | |
| Round | Ø 1000 | ✓ | ✓ | | | |
| Round | Ø 1200 | ✓ | ✓ | | | |
| Rectangular | 700 x 1100 | ✓ | ✓ | | | |
| Rectangular | 800 x 1200 | ✓ | ✓ | | | |
| Rectangular | 800 x 1400 | ✓ | ✓ | | | |
| Rectangular | 900 x 1800 | ✓ | ✓ | | | |

Table top colours on page 280 - 281

On request, table tops can be produced in different sizes and colours. Please contact with our sales team.

TOP COLOURS

SOLID COMPACT TABLE TOP COLOURS AND ECO RANGE SOLID COMPACT TABLE TOPS

Except white, other colours are recommended only in shades areas



1050M White



1049M Black



1057M Anthracite

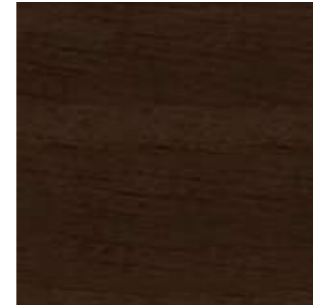

3039M Wenge



3120M Rustica



5101STN Chement



5056M Botanico Brown



3169M Novacento



1049WGR1 Woodgrain Nero



3177M Linewood

LAMINATE CHIPBOARD TOP COLOURS (WITH ABS EDGE)



9700 Wenge



9800 White

TOP COLOURS

POLIMER LAMINATED MDF CORE TABLE TOP COLOURS



0074 Gold



0076 Yellow



0077 Black



0079 Pear



0081 Cream



0083 White



0084 Grey



0086 D. Walnut



0087 Maple



0089 Wenge



0090 Claret red



0091 Orange

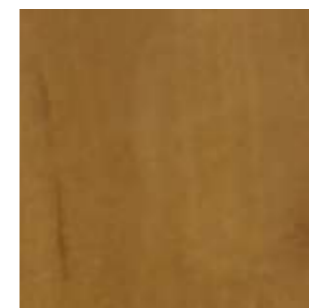

0093 Walnut



0096 Cherry



0099 D. cherry

METAL BASE COLOURS

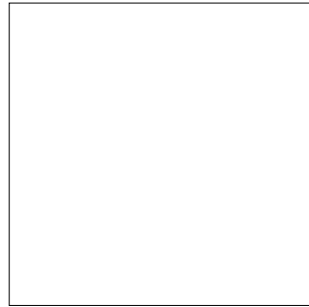

101 White / RAL 9016
Powder Coated Mat



102 Black / RAL 9005
Powder Coated Mat



103 Anthracite / RAL 7016
Powder Coated Mat



104 Taupe / RAL 1019
Powder Coated Mat



105 Silver Metallic / RAL 9006



106 Chrome



107 Brushed Stainless



108 Polished Stainless



109 Satin Anodized Aluminium



110 Dark Yellow / RAL 1037
Powder Coated Mat



111 Brick Red / RAL 530-1
Powder Coated Mat



112 Reseda Green / RAL 6021
Powder Coated Mat



113 Brass



114 Copper



115 Grey / RAL 7005
Powder Coated Mat

